

Inkjet Printing

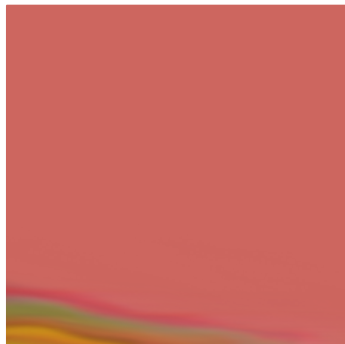
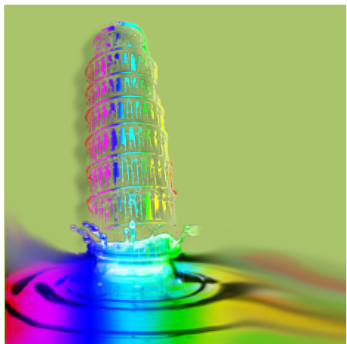
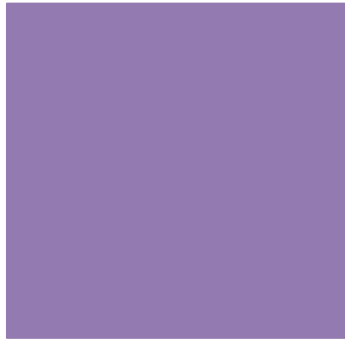

carmelo.demaria@centropiaggio.unipi.it

+ Ink-jet technology

- The ink-jet technology is a contact free dot matrix printing procedure. Ink is issued from a small aperture directly onto a specific position on a medium



+ Inkjet technology

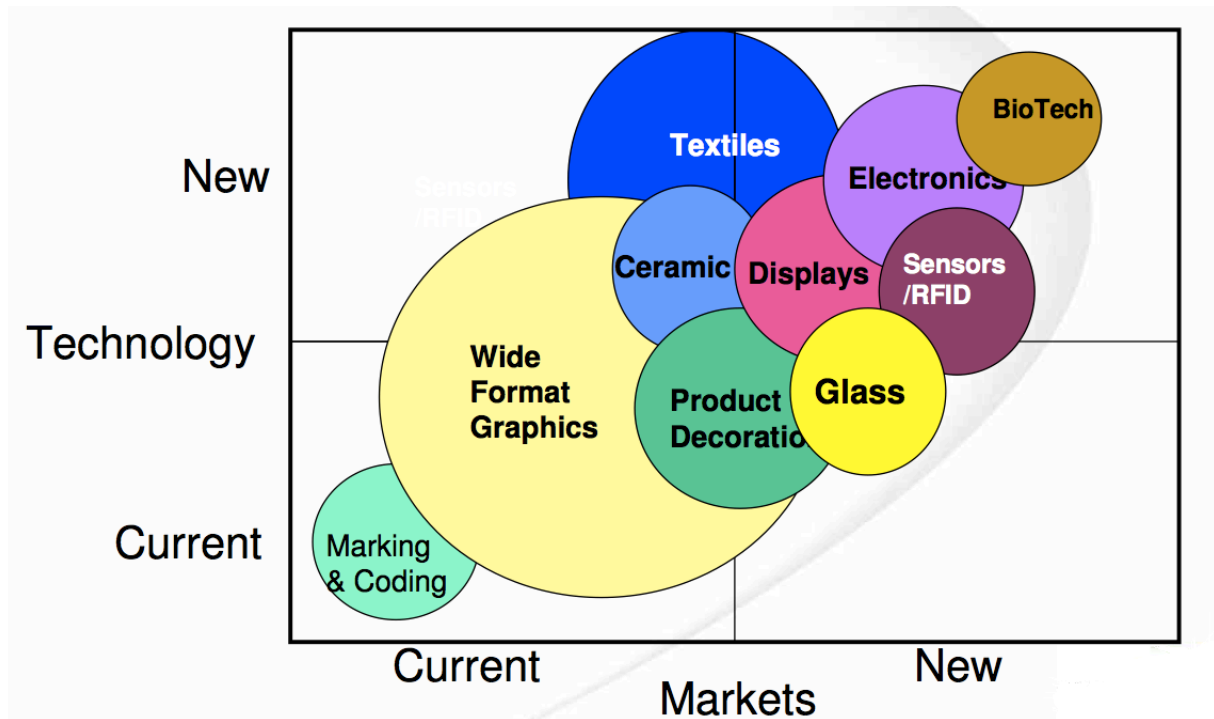

+ Inkjet technologies

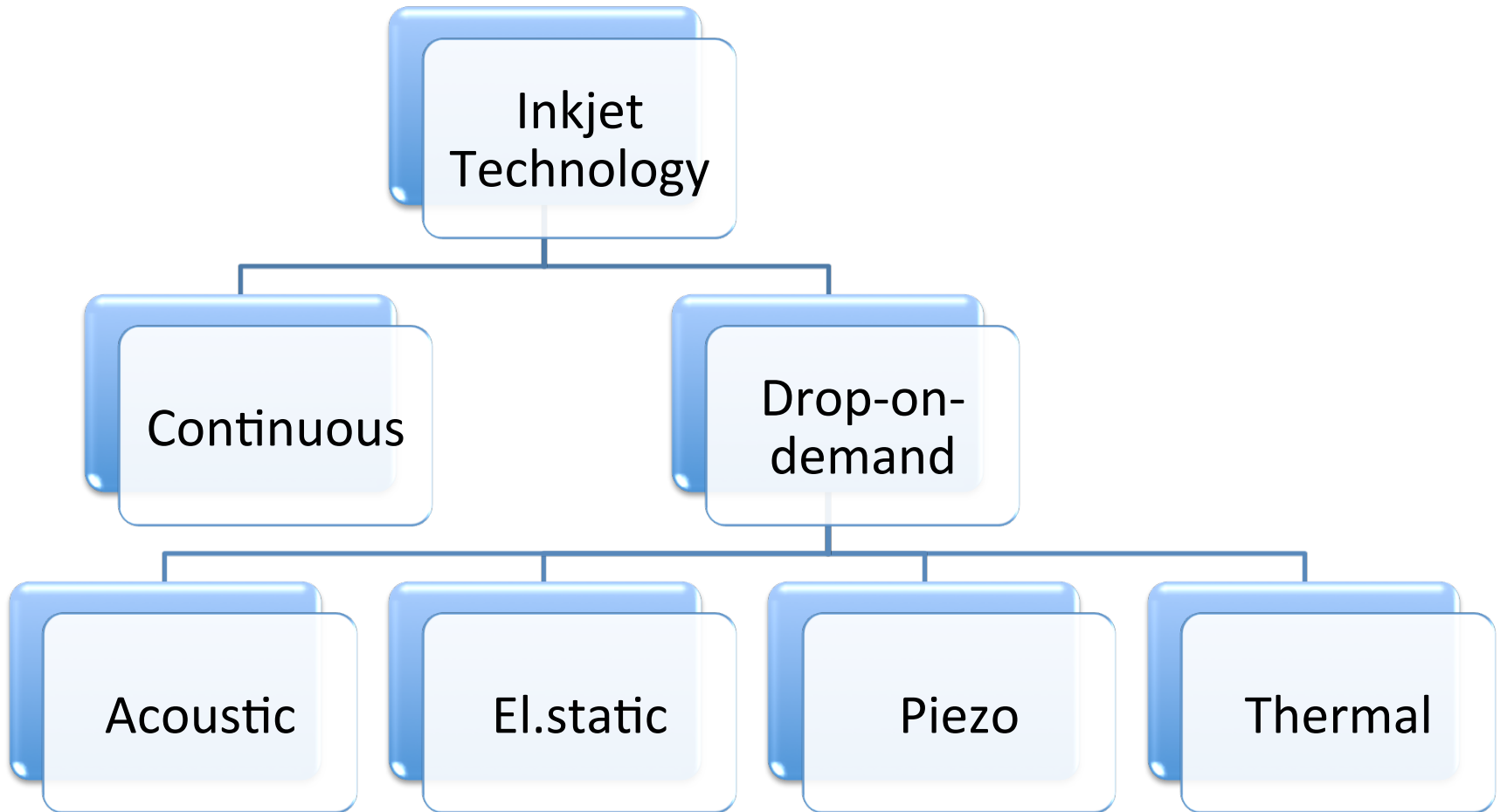

+ Mechanisms of drop formation

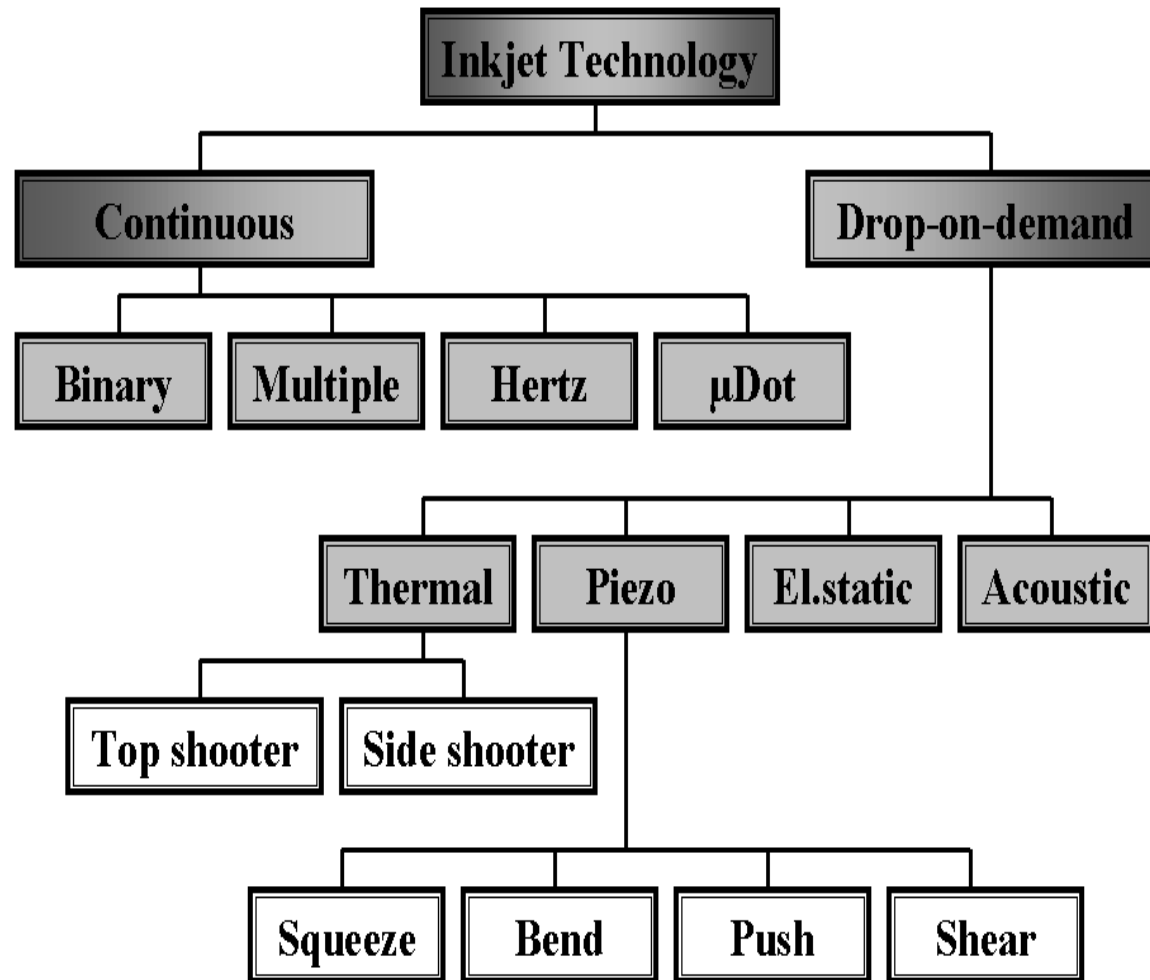

+ Continuous Ink-Jet (CIJ)

- Plateau-Rayleigh instability
 - A falling stream of fluid breaks up into smaller drops (the liquid is unstable)
 - When a jet is thin enough, the effect of gravity is negligible compared to surface energy
 - The jet changes its shape to reduce the total surface energy
 - Liquid flow sets the time.

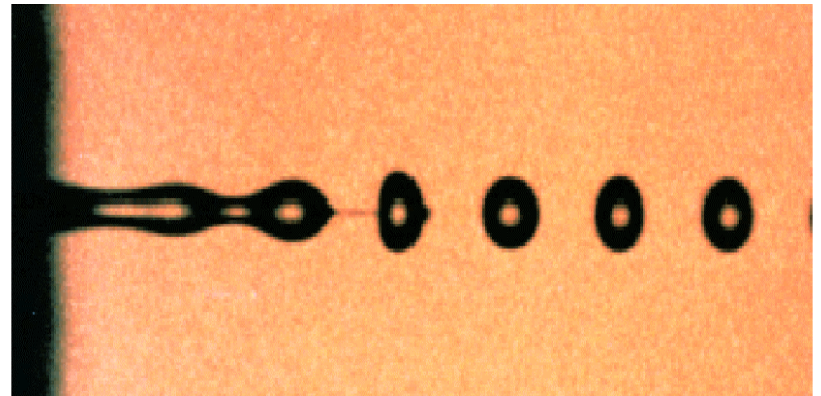

+ Continuous Ink-Jet (CIJ)

- Minimum of surface energy
- Varicose perturbation (unstable system)
- No constant radius of curvature
- Time and length scale
- Drop radius

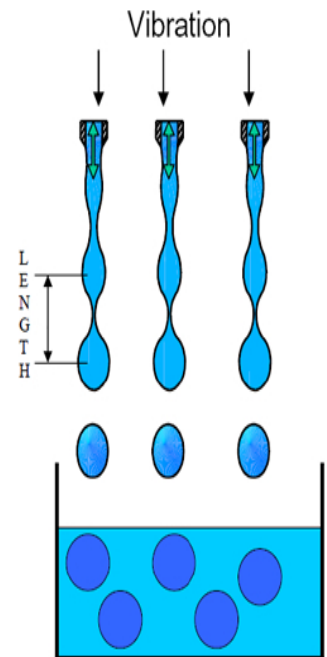

+ Continuous Ink-Jet (CIJ)

- Dedicated charging of droplets
- Recirculation by deflection in transversal electrical field

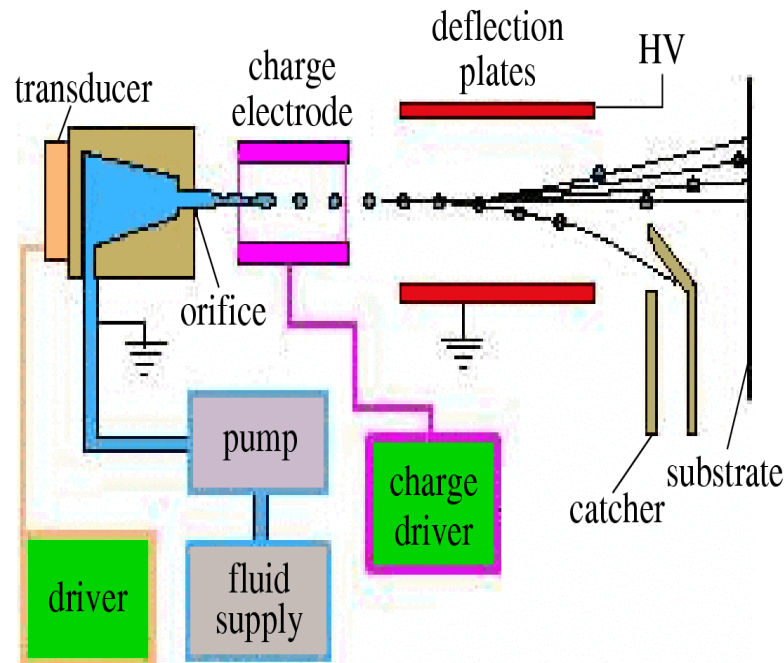

+ Continuous Ink-Jet (CIJ)

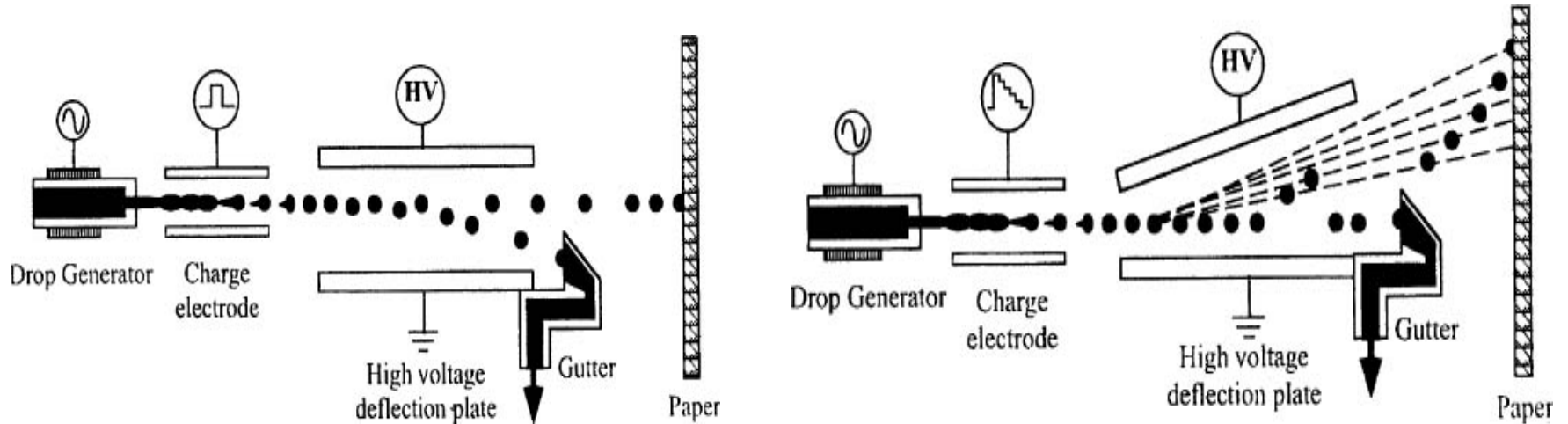

- Binary deflection
 - Uncharged droplets deposited on substrate
 - Charged droplets recirculate
- Multiple deflection
 - Uncharged droplets recirculated by gutter
 - Charged droplets deflected according to q/m ratio
 - 2-dimensional writing of small areas with single nozzle

+ Continuous Ink-Jet (CIJ)

- Droplet delivery
 - Emission of cylindrical plug from orifice
 - Stimulated break-off (induced varicosity)
 - Charging by passing electric field (ring or tunnel)
 - Orifice diameter 50-80 μm
 - Droplet size \cong 120 μm (volume 4fl – 1pl)
 - Droplet frequencies in order of 100 kHz
 - Frequently satellite droplets formed

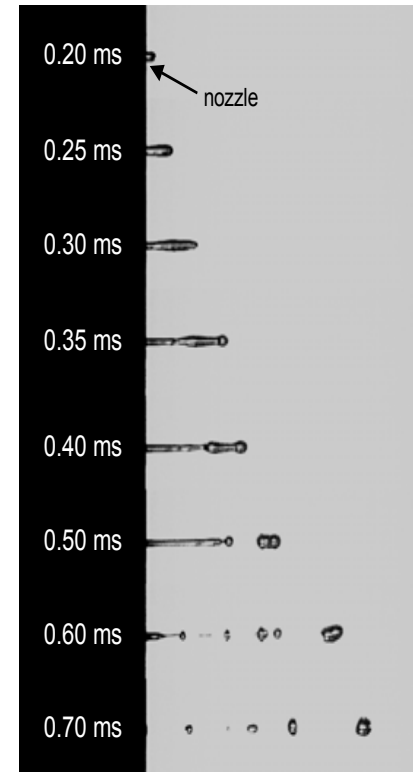

+ Continuous Ink-Jet (CIJ)

- Drawbacks
 - Complex recirculation
 - Deflection according to charge-to-mass ratio (limited accuracy)
 - Restriction to conducting ink formulas
 - Low quality
- Application
- Industrial small-character printing (SCP)
 - Zanasi
 - <http://www.youtube.com/watch?v=BZfjcNDj4uY>



DROP ON DEMAND (DOD)

+ Drop On Demand (DoD)

- Mechanism of droplet formation:
 - Thermal
 - Piezo-electric
 - Electrostatic
 - Acoustic

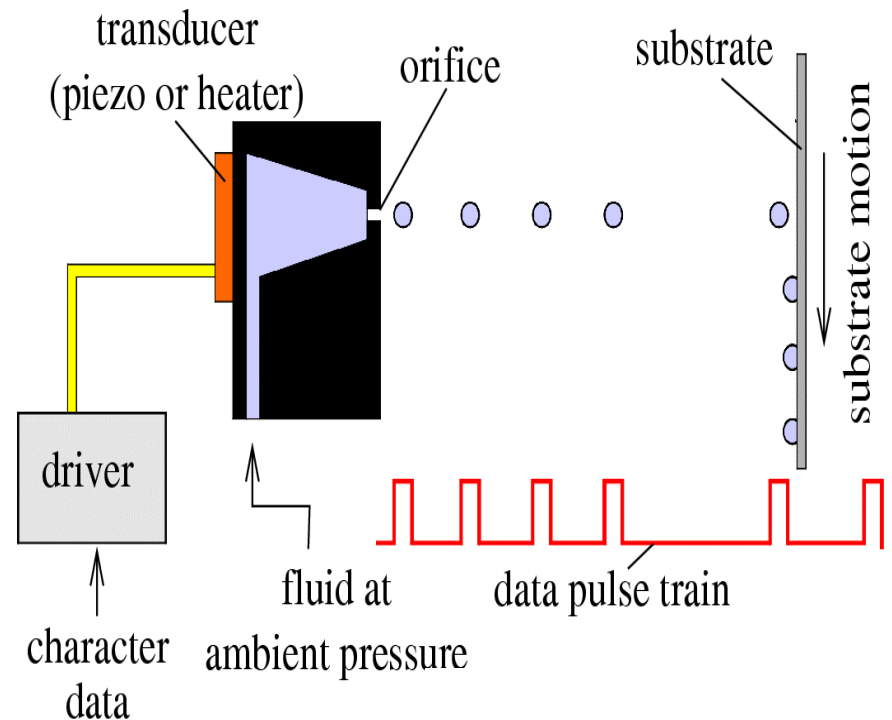

+ DoD – Thermal Ink-Jet (TIJ)

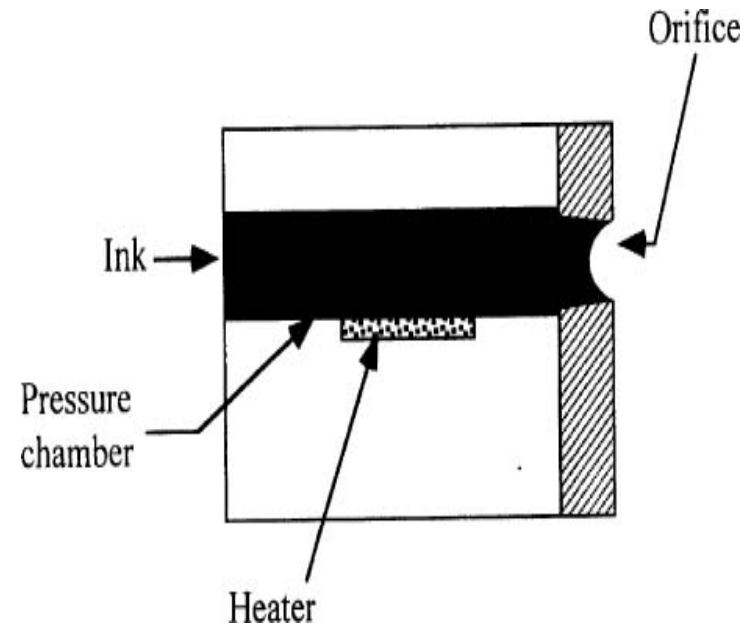
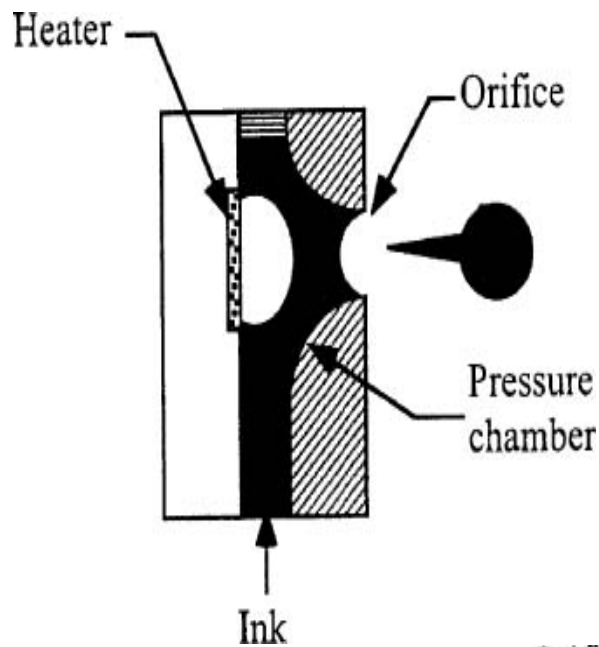

- Roof shooter
 - Heater above orifice (HP, Lexmark, Olivetti)
- Side shooter
 - Heater lateral to orifice (Canon and Xerox)



DoD – Thermal Ink-Jet (TIJ)



- Phase of droplet formation
- Heating
 - Overheated ink (over the spinodal limit, around 300°C for water)
 - At 300°C: nucleation of bubble
- Expansion
 - Ejection of ink
 - Parallel to bubble expansion
- Droplet formation
 - Collapsing vapour bubble
 - Retraction of bulk ink
 - Refilling of cavity (80-200 us, speed critical step)

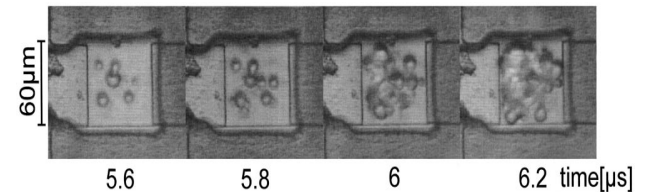
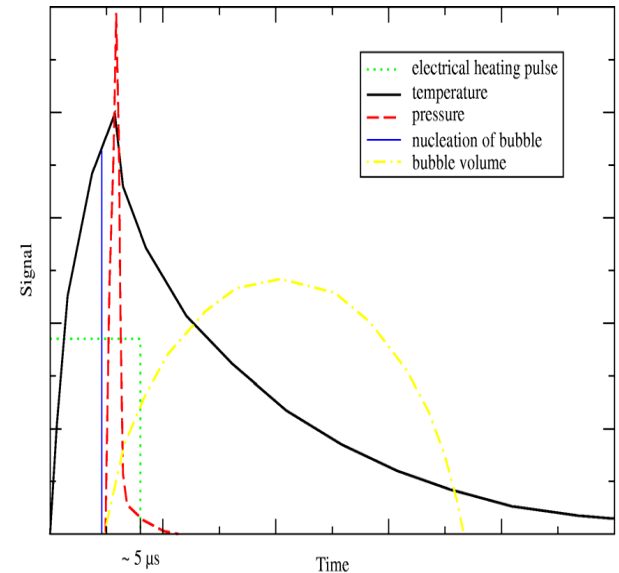
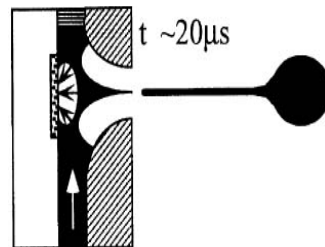
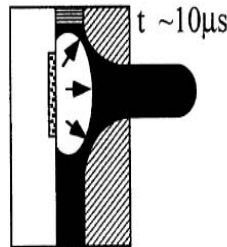
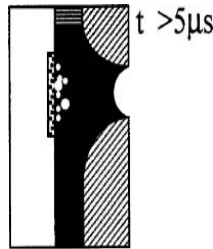

+ DoD – Thermal Ink-Jet (TIJ)

- Example: nozzle of DJ 850C color printhead
- Roof shooter
- 6000 droplets a 32 pl per second (cycle time 170 us)
- Width and height of ink channel on um range
- Critical production parameters
 - Dimensional stability
 - Precision
 - Uniformity of nozzles
- Drop performance
 - Frequency
 - Volume
 - Speed

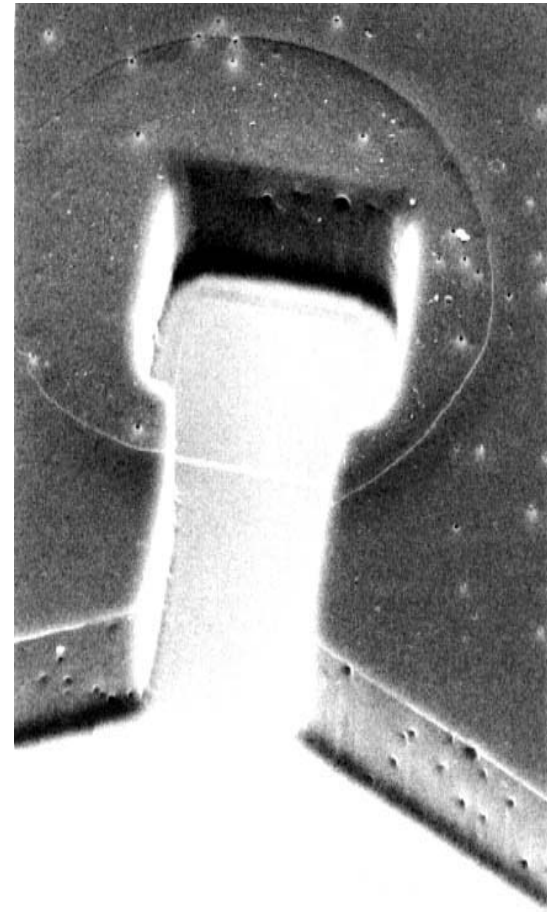

+ DoD – Thermal Ink-Jet (TIJ)

- A case of study

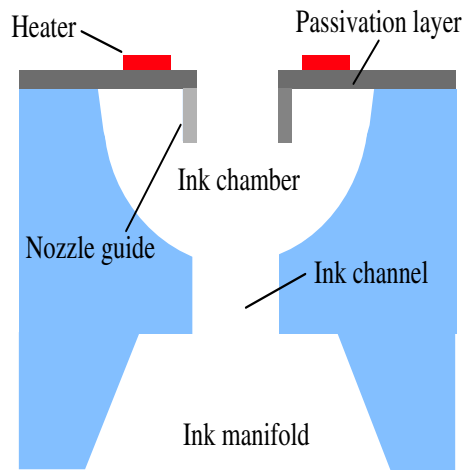
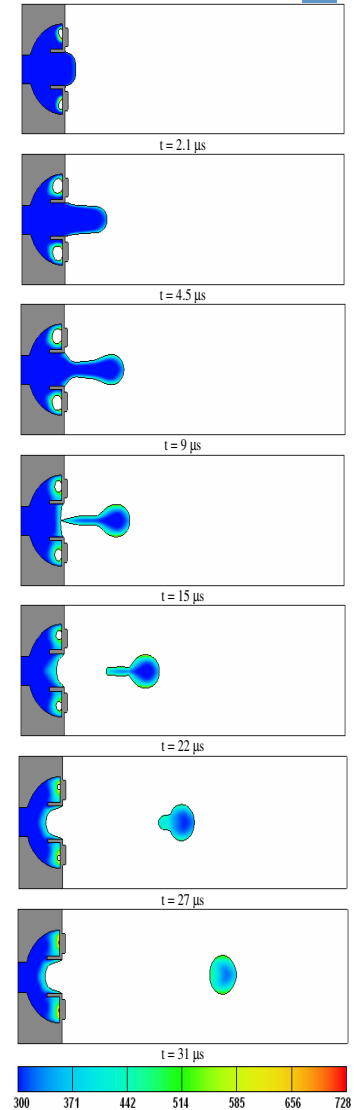
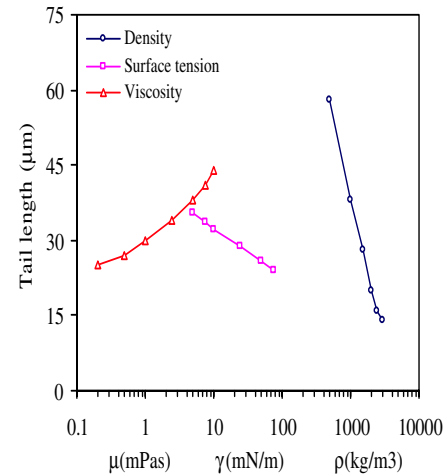
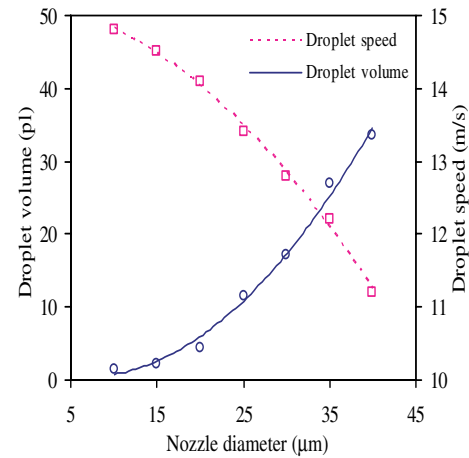
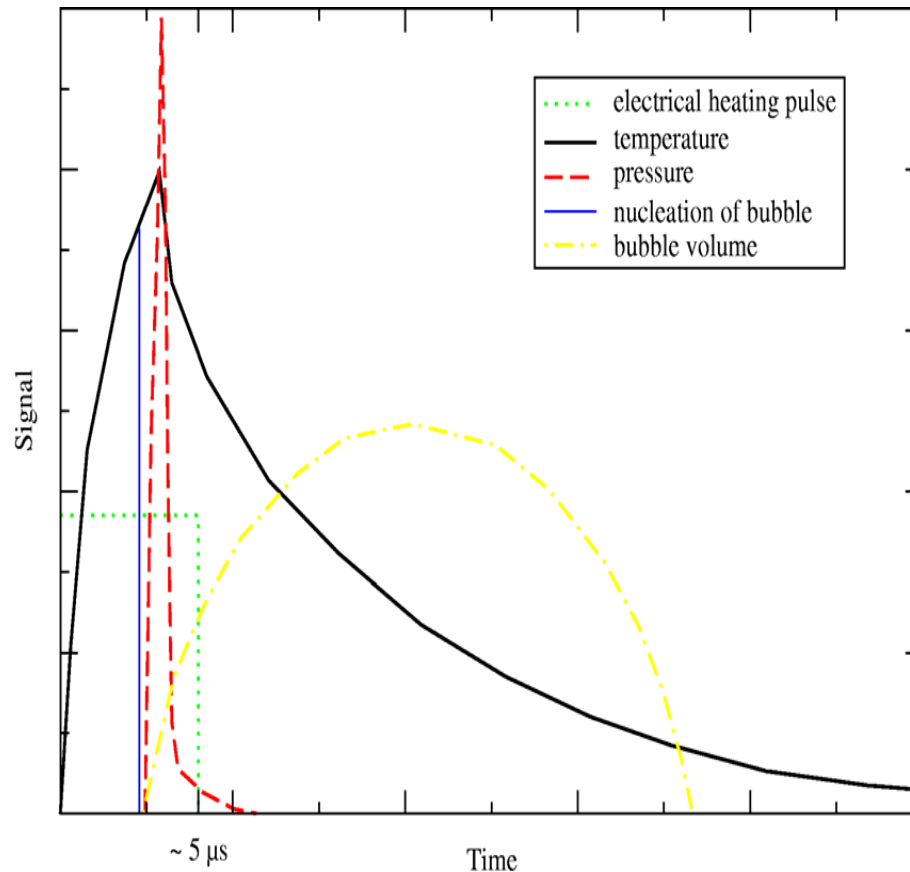

Figure 1. A cross-sectional view of the inkjet print head.



+ Exercise

- Estimate the penetration depth of the temperature into a drop during thermal inkjet printer.



+ DOP – piezo-electric IJ

- Deformation of piezo-ceramics
- Change in volume
- Pressure wave propagates to nozzle
- Deflection of piezo-ceramics in submicrometric range
- Piezo-element has to be much larger than orifice
- Main problem: miniaturization

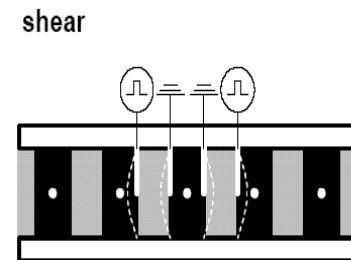
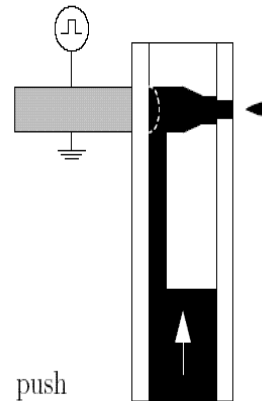
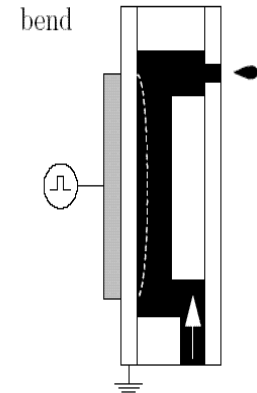
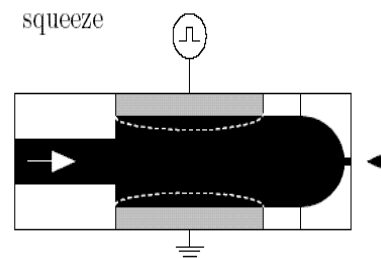

+ DOP – piezo-electric IJ

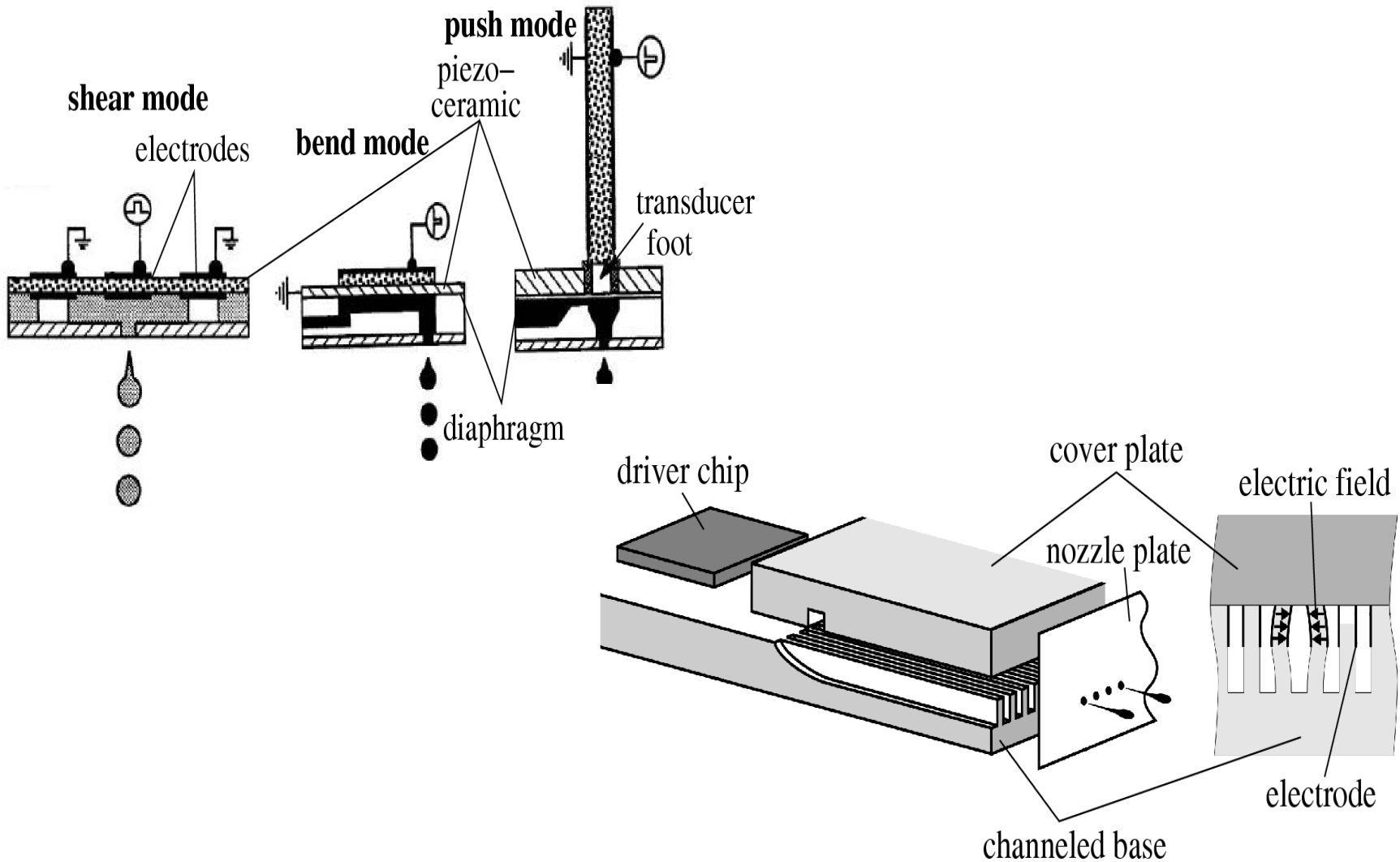

+ DOP – piezo-electric IJ

- OmniJet 100 – samsung cartridges
- Signal waveform

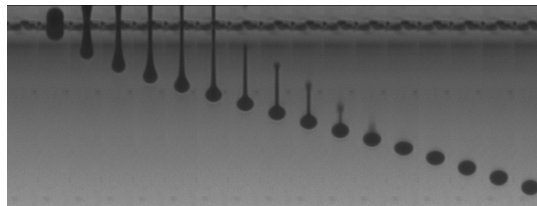
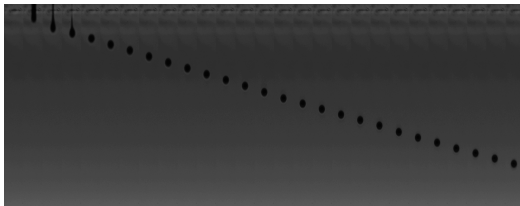
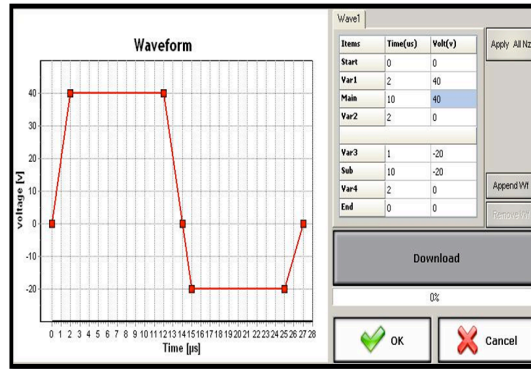
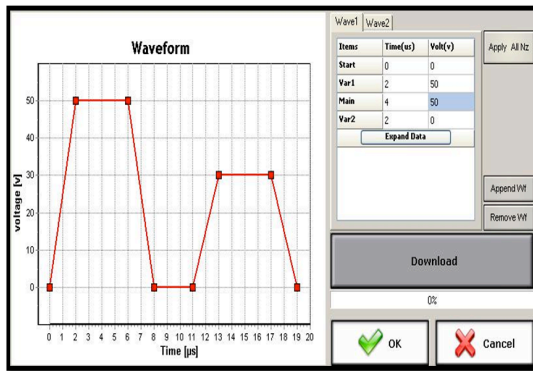

	SPECIFICATION
Number of Nozzles	16 nozzles
Nozzle Spacing	508 µm (50 DPI, single row)
Driving voltage	< 100V
Jetting frequency	up to 30 kHz
Droplet volume	1, 5 & 30 pL (3 types)
Operating temp.	< 50 °C
Reservoir capacity	5 mL
Size (W×L×H)	39 mm × 16 mm × 56 mm

+ Nozzle design

- Geometry parameters of nozzle
 - Diameter
 - Depth
- Effect on droplets
 - Volume
 - Speed
 - Deflection angle
- Effect on ink supply (refilling)
 - Capillary forces
- Fabrication tolerances limit picture quality
- Fabrication of orifice plates
 - Laser-ablation in polyimide, especially for small nozzles (10 pl, 20 μm)
 - Nickel-electroplating
 - Electro-discharge machining (EDM)
 - Micro-punching
 - Micro pressing

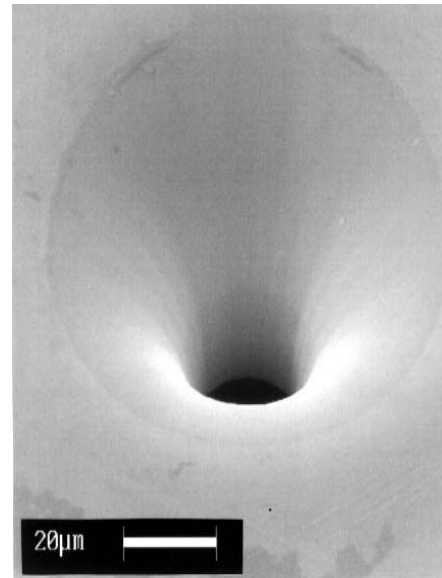

Electroplated Ni-nozzle

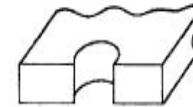

Cylindrical orifice
(Tektronix, Sharp)

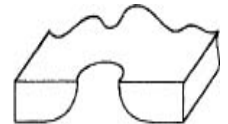

Convergent orifice
(HP, Dataproducts)



Tapered orifice
(Canon)

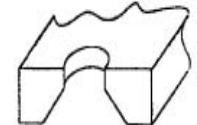

Tapered with cylindrical
exit orifice
(Seiko-Epson)

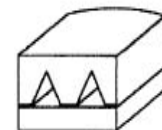

Triangle orifice
(Xerox)

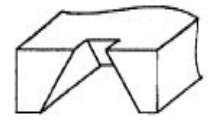

Square orifice
(IBM)

+ Nozzle design

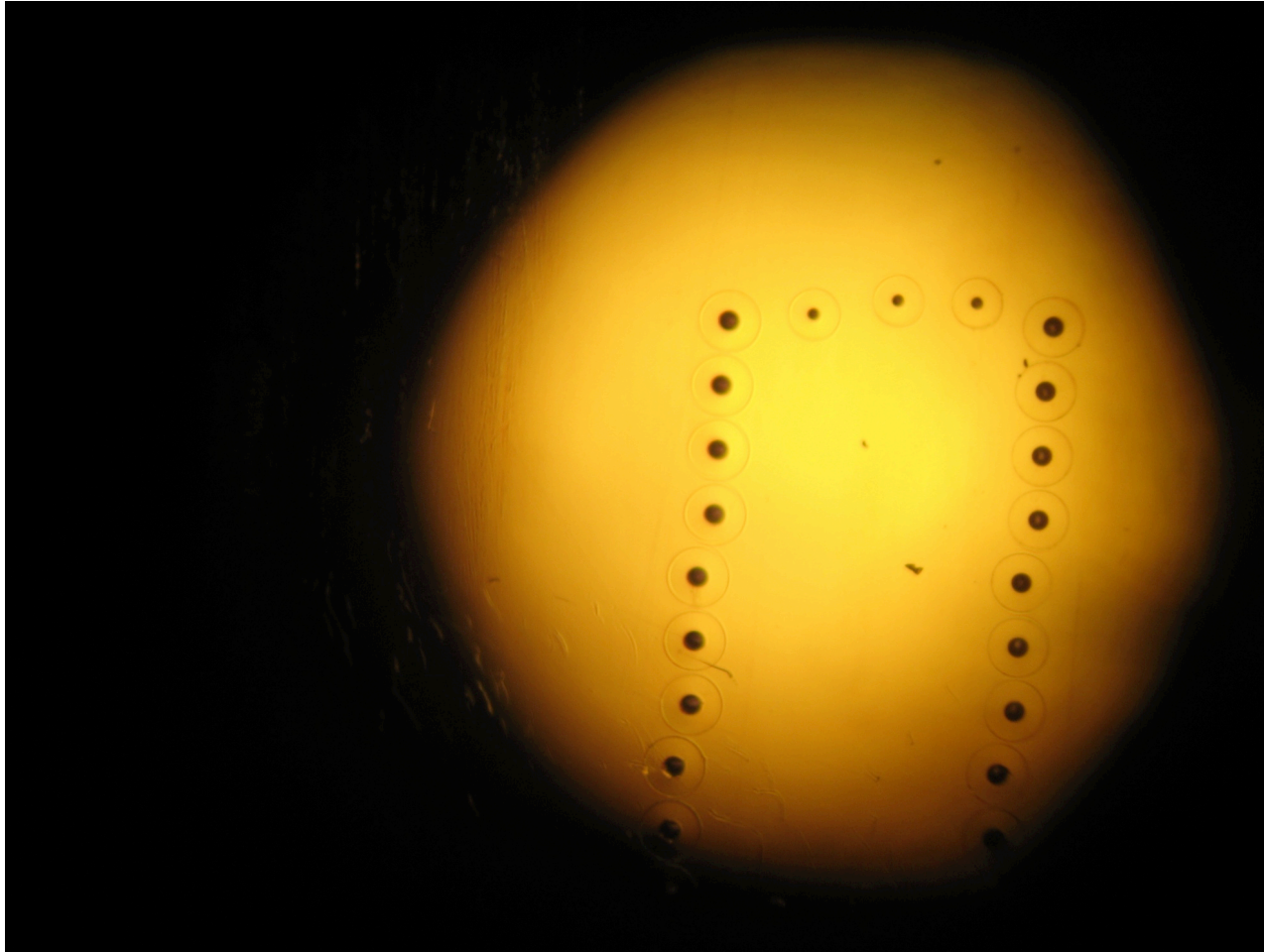

+ Cartridge Design

- HP cartridge
 - Bubble generator
 - Accumulator

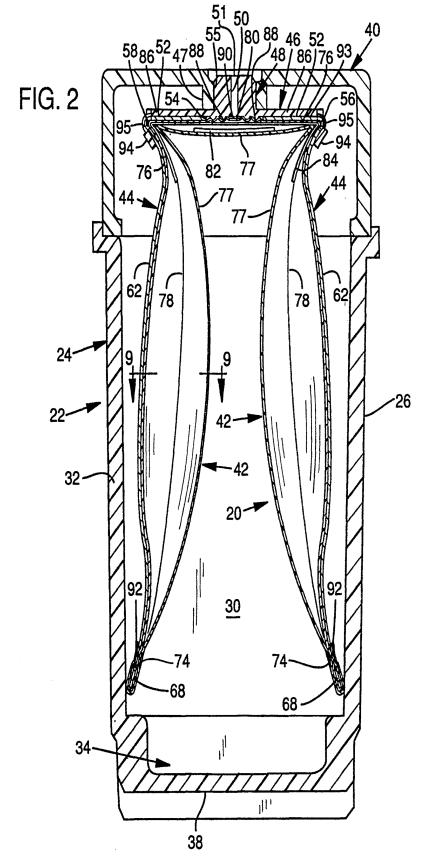
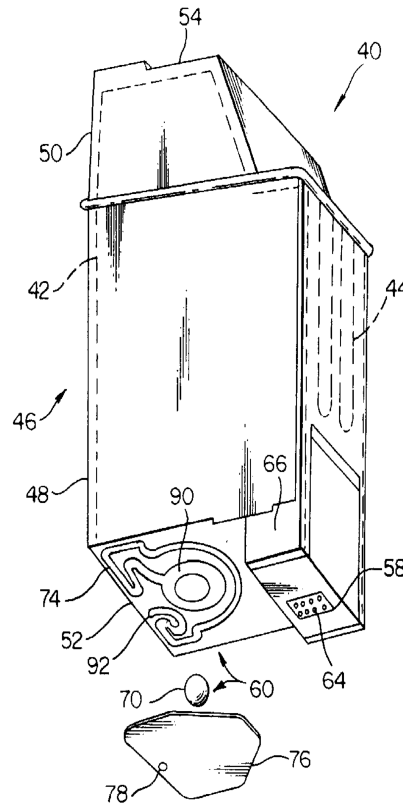

OTHER TYPES

+ Ultrasonic droplet generation

- Acoustic transducer
- Constructive interference of waves
 - Similar to Fresnel lens

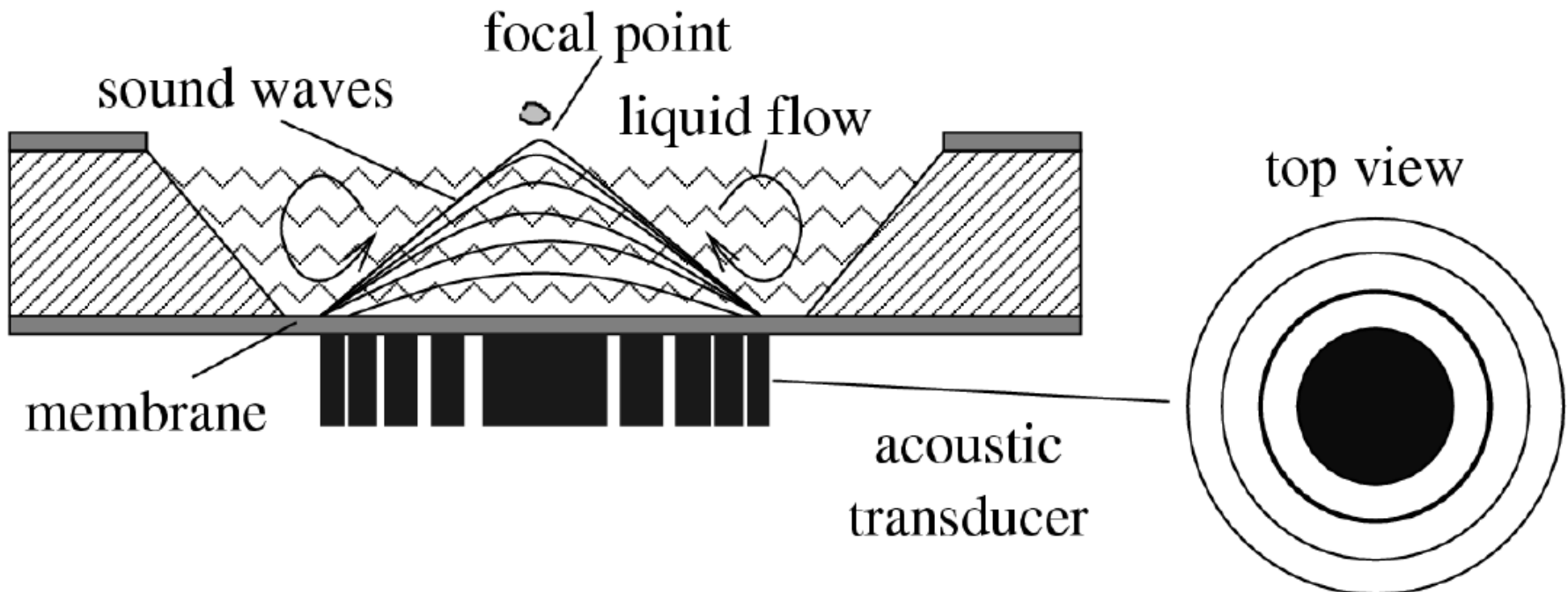

+ Valve jet

- Non-contact principle
 - Drop-on-demand
 - Often confused with impulse jet
- Working principle
 - Ink held under pressure
 - Dynamic opening of valve
 - Micro-electromechanical
- Spraying of fine jet



+ Valve jet



Initial position	NC (Normally closed)
Shot size	From 3 nl
Viscosity range	0.5 – 10,000 mPas (thixotropic)
Accuracy	> 97 % (Dispensing tolerance < 3 %)
Frequency	Up to 280 shots/sec (Hz)
Fluid pressure	0.2 to 6 bar (up to 100 bar)
Operating medium	dry compressed air, oil-free, filtered (filter unit 40 µm)
Operating pressure	4 to 8 bar
Switching time	Starting at 2 ms
Electrical input	24 V, PLC compatible
Service life	> 100,000,000 cycles
Weight	270 g
Ambient temperature	-5 to +40 °C
Actuator	Electropneumatic
Construction	Robust industrial design, class II equipment, splashproof in accordance with IP 65