

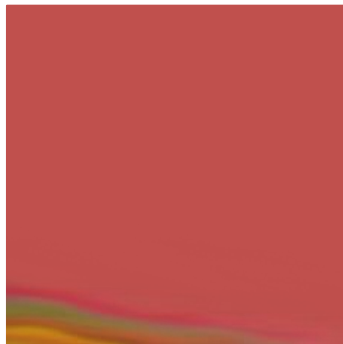

Centro E. Piaggio
bioengineering and robotics research center

Fused deposition Modelling

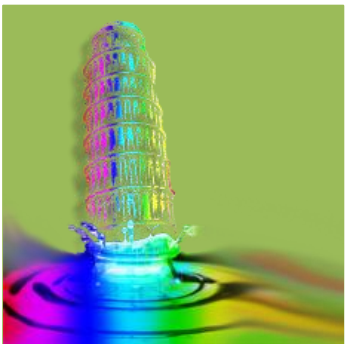
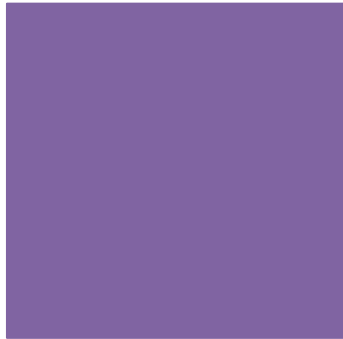

carmelo.demaria@centropiaggio.unipi.it

+ Fused deposition modelling (FDM)



- FDM is the second most widely used rapid prototyping technology, after stereolithography.
- A plastic filament is unwound from a coil and supplies material to an extrusion nozzle. The nozzle is heated to melt the plastic and has a mechanism which allows the flow of the melted plastic to be turned on and off.
- The nozzle is mounted to a mechanical stage which can be moved in both horizontal and vertical directions.
- As the nozzle is moved over the table in the required geometry, it deposits a thin bead of extruded plastic to form each layer.
- The plastic hardens immediately after being squirted from the nozzle and bonds to the layer below. The entire system is contained within a chamber which is held at a temperature just below the melting point of the plastic.

+ Fused deposition modelling (FDM)

<https://www.youtube.com/watch?v=WHO6G67GJbM>



+ Fused deposition modelling

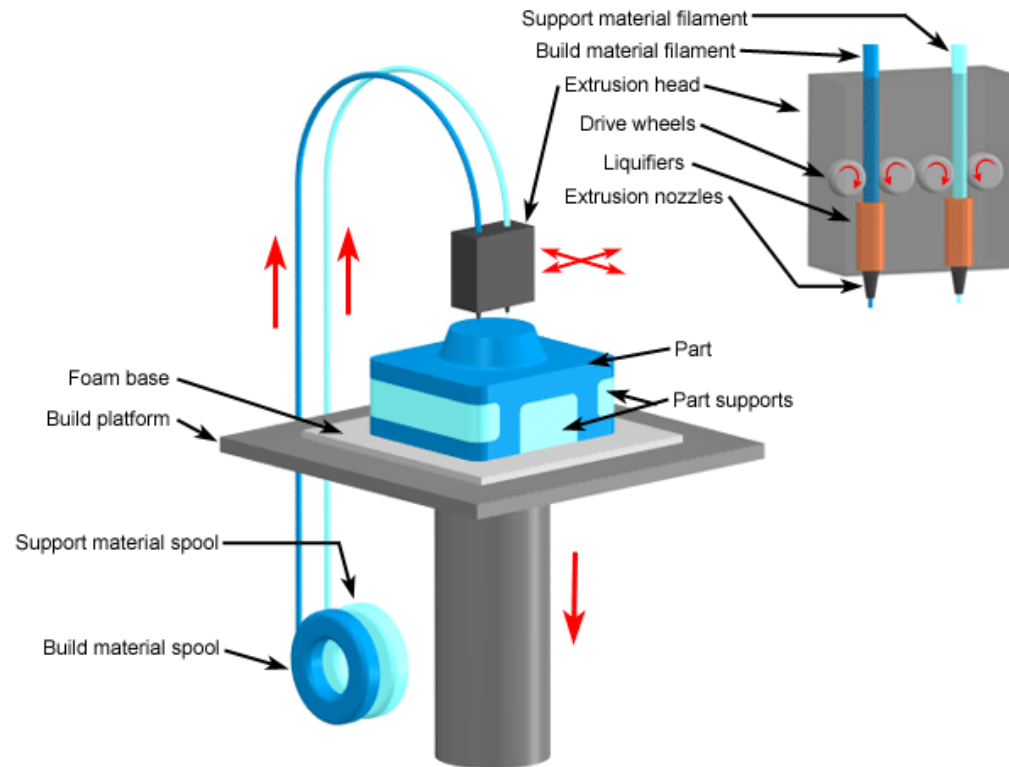

With basics of polymer rheology

MATERIALS FOR FDM

+ Materials

- FFF = Fused Filament Fabrication
- Filament: fine diameter plastic that exits from an extruder (some may refer to the plastic feed stock as filament as well)
- Typically, the diameter of the filament varies between 1 mm and 3mm
- The standard extruder produces filament using high pressure and heat to force molten plastic thru a very tiny hole.



+ Materials

- “Standard” materials:
 - Poly-Lactic-Acid (PLA) (soft and hard)
 - Acrylonitril-Butadiene-Stiren (ABS)
- “Experimental” materials:
 - Nylon
 - Polycarbonate (PC)
 - Poly vinyl alcohol (PVA)
 - Conductive (carbon and graphen loaded materials)
 - Metallic loaded plastics





Rheology

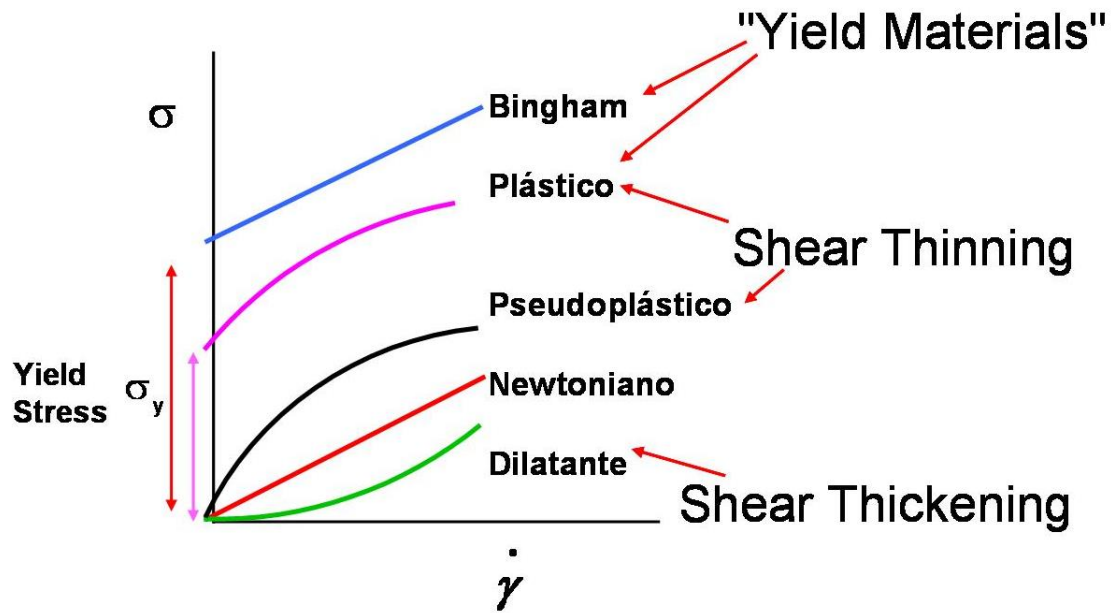

+ Variabili che influenzano la reologia dei polimeri



- Variabili reologiche:
 - deformazione
 - velocità di deformazione
- Variabili strutturali-compositive:
 - peso molecolare medio
 - polidispersità (M_w/M_n)
 - architettura molecolare (es: presenza di ramificazioni)
 - presenza di una fase dispersa (quantità, dimensionale media e distribuzione, forma)
 - contenuto di additivi (es: plastificanti)
- Variabili termodinamiche:
 - pressione
 - temperatura

+ Curva di flusso (viscosità in regime stazionario):
comportamento shear thinning

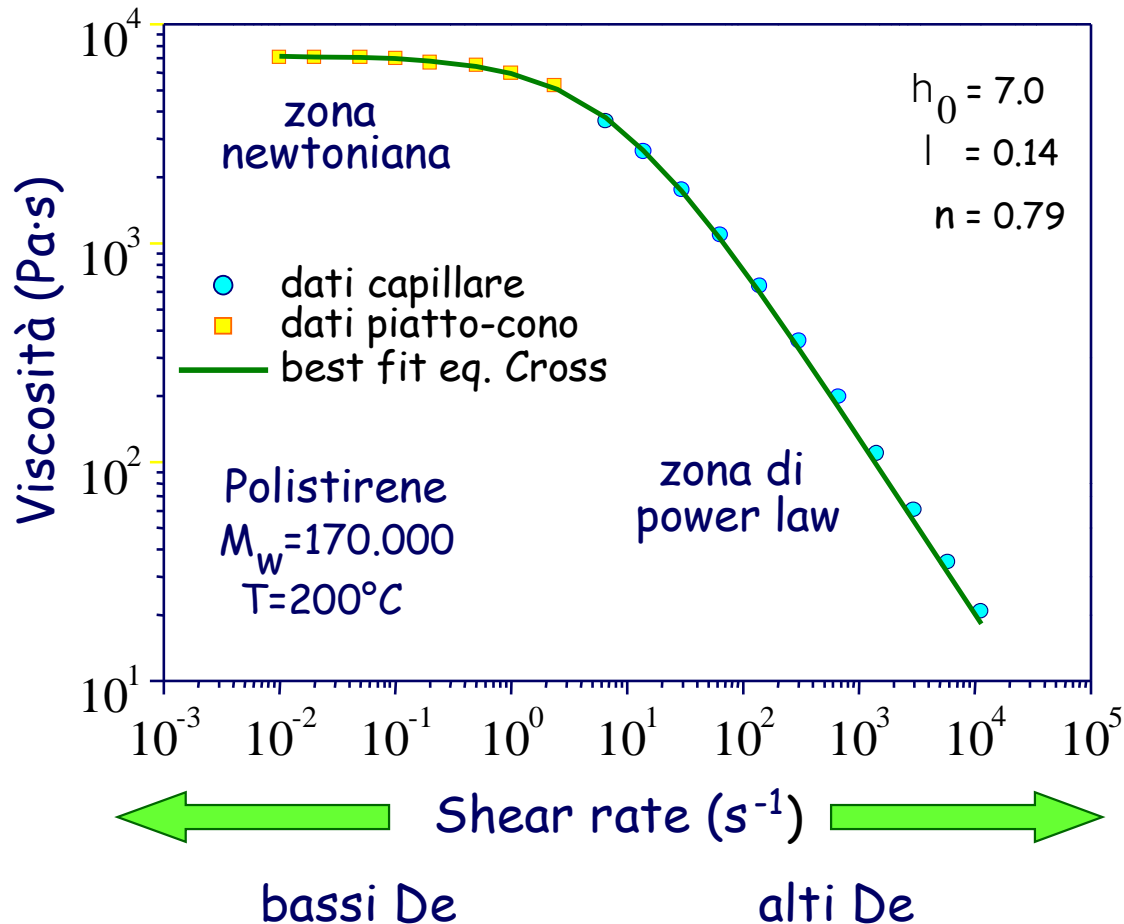

$$\eta = \frac{\eta_0}{1 + (\lambda \dot{\gamma})^n}$$

+ Viscosità e condizioni tipiche di processo

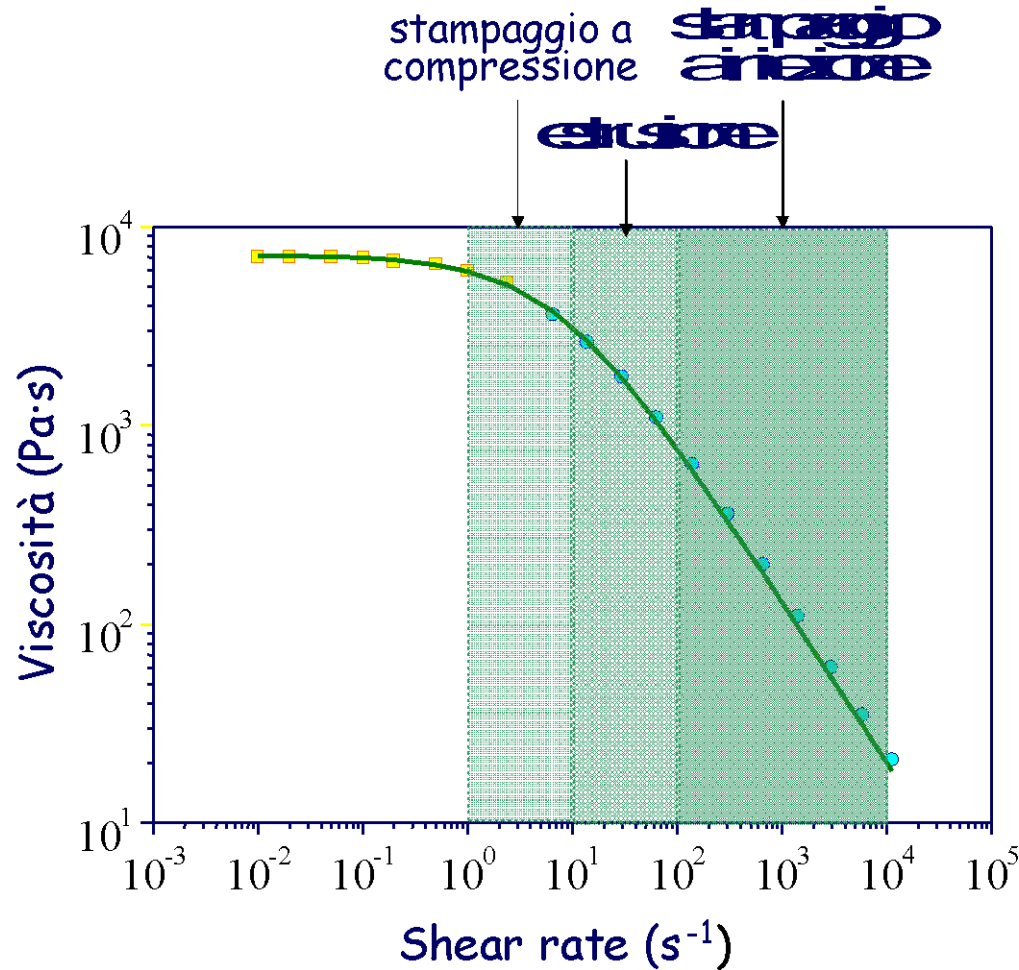

+ Effetto del peso molecolare

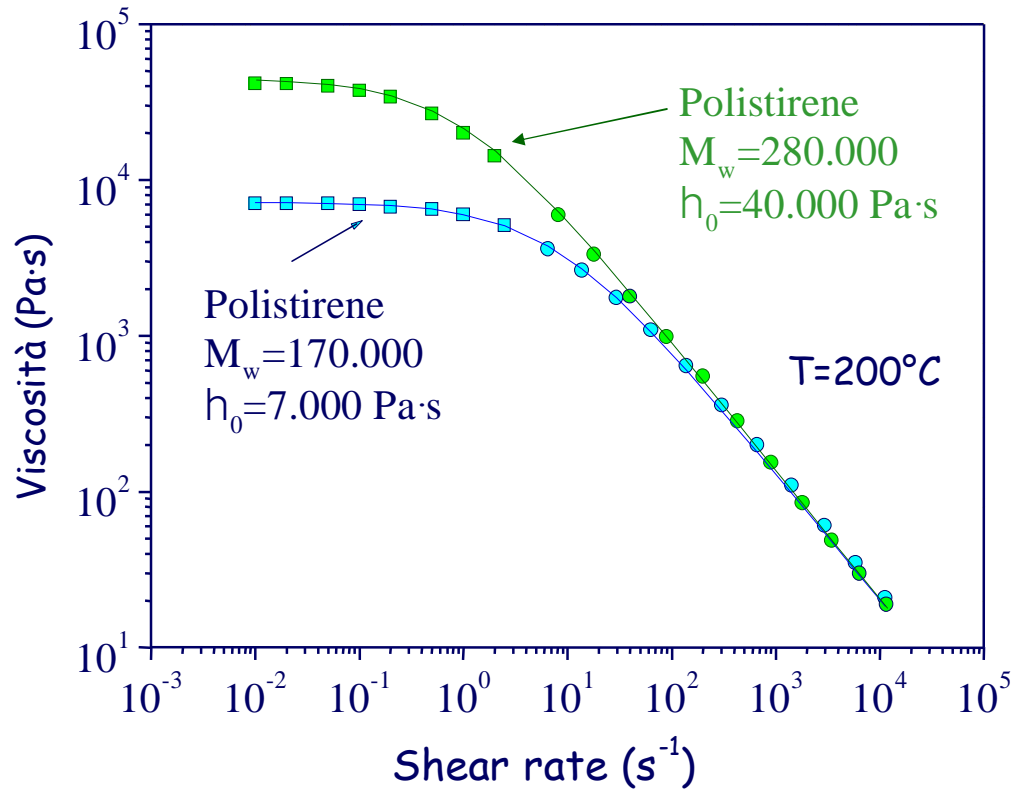

Una caratteristica distintiva dei polimeri ad alto peso molecolare:

$$h_0 \propto M_w^{3.4}$$

+ Effetto della polidispersità

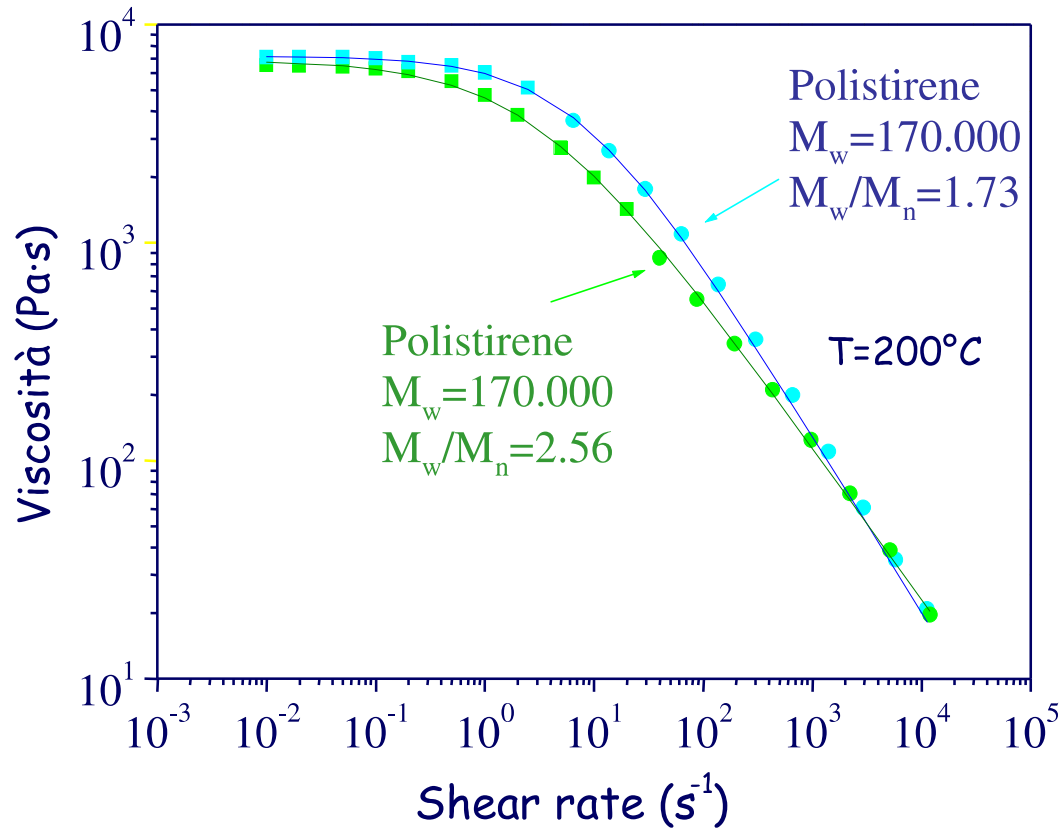

Maggiore è la polidispersità e più larga è la curva di viscosità



Indice di polidispersione

Da Wikipedia, l'enciclopedia libera.

L'**indice di polidispersione** è una misura dell'uniformità di distribuzione dei **pesi molecolari** in un determinato **polimero**. La **polidispersità** viene espressa tramite un indice calcolato dal rapporto tra la **massa molare media ponderale** e la massa molare media numerica del polimero, essendo:

- *massa molare media numerica*: $M_n = \frac{\sum n_i M_i}{\sum n_i}$
- *massa molare media ponderale*: $M_w = \frac{\sum w_i M_i}{\sum w_i} = \frac{\sum n_i M_i^2}{\sum n_i M_i}$

in cui:

- M_i = massa molecolare dell'*i*-esima molecola;
- n_i = numero di **moli** delle molecole aventi massa molecolare pari a M_i ;
- w_i = massa delle molecole con massa molecolare pari a i .

Siccome la massa molare media ponderale è sempre maggiore della massa molare media numerica, l'indice di polidispersività (essendo pari al rapporto M_w/M_n) assume sempre valori maggiori di 1.

Il termine "monodisperso" viene per convenzione utilizzato fino a valori di indice di polidispersività minore a 1,1.^[1] In caso contrario il polimero è detto "polidisperso".

Nel caso di polimeri ottenuti tramite **polimerizzazione a stadi** si hanno valori dell'indice di polidispersione più bassi (intorno a 2), mentre nel caso di polimeri ottenuti tramite **polimerizzazione a catena** si hanno valori di polidispersione più elevati.

+ Fenomeni dovuti all'elasticità del fuso

le componenti elastiche sono legate agli sforzi normali

rod climbing

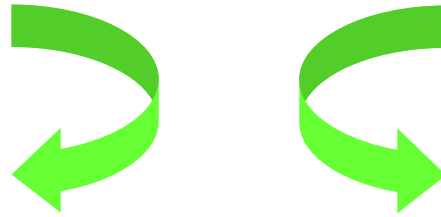
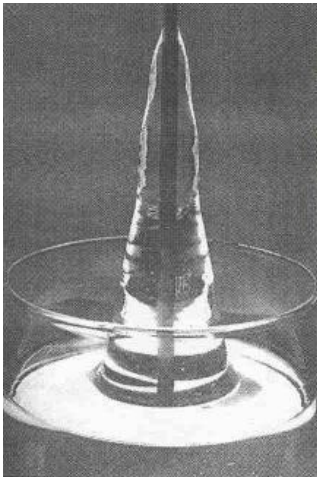

die swell

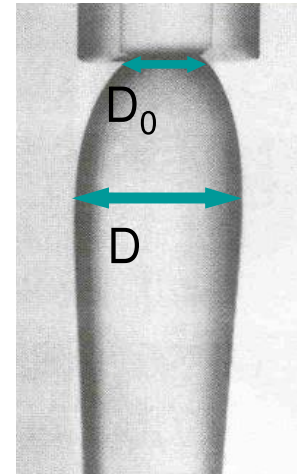

$$B = \frac{D}{D_0}$$

+ Il die swell del polistirene

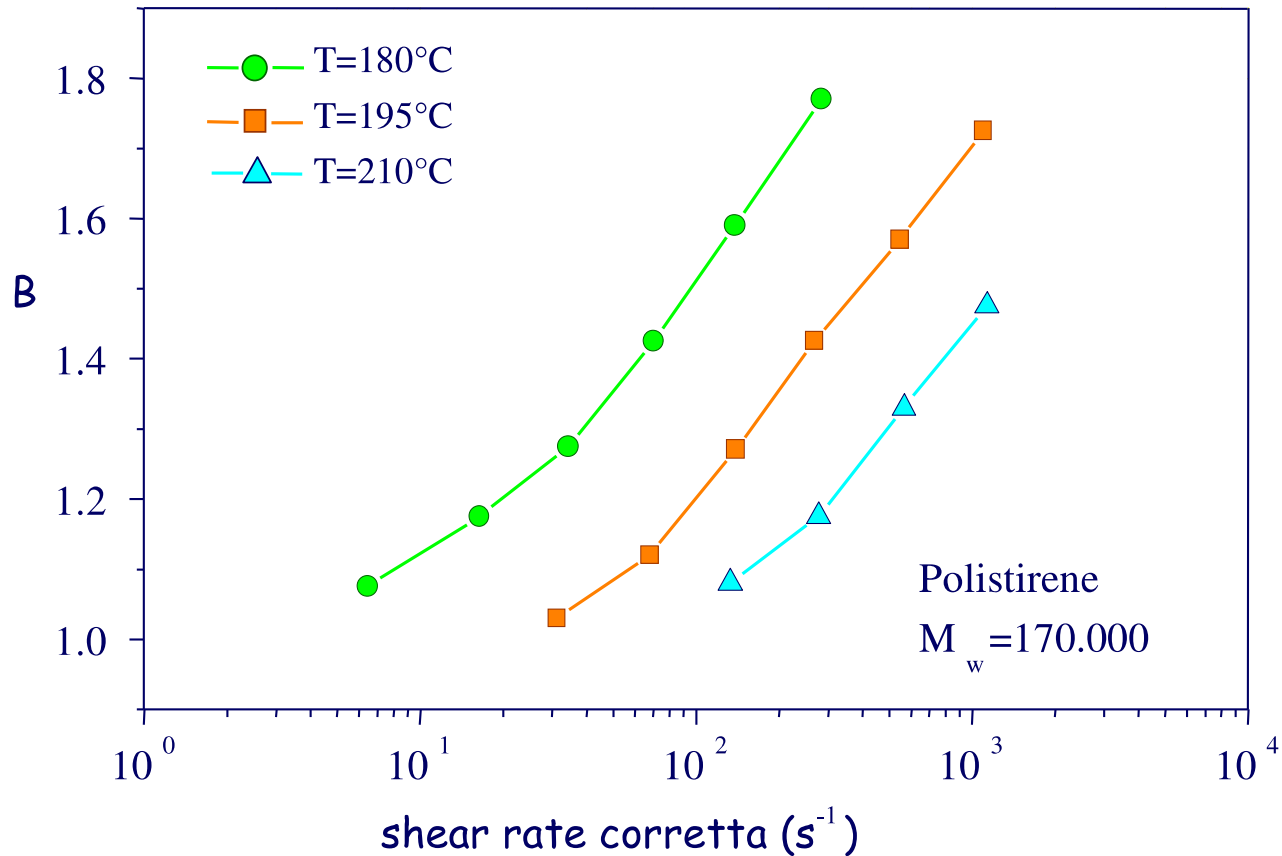

+ Altra manifestazione dell'elasticità del fuso: la pressione di ingresso

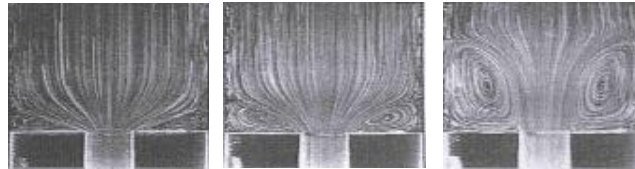

shear rate crescente

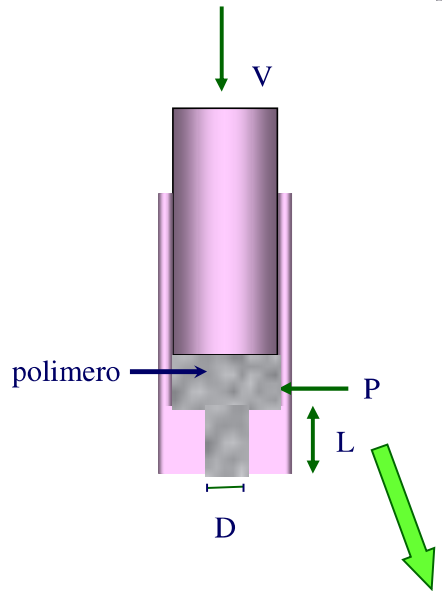

$$P = P_{ing} + P_{visc}$$

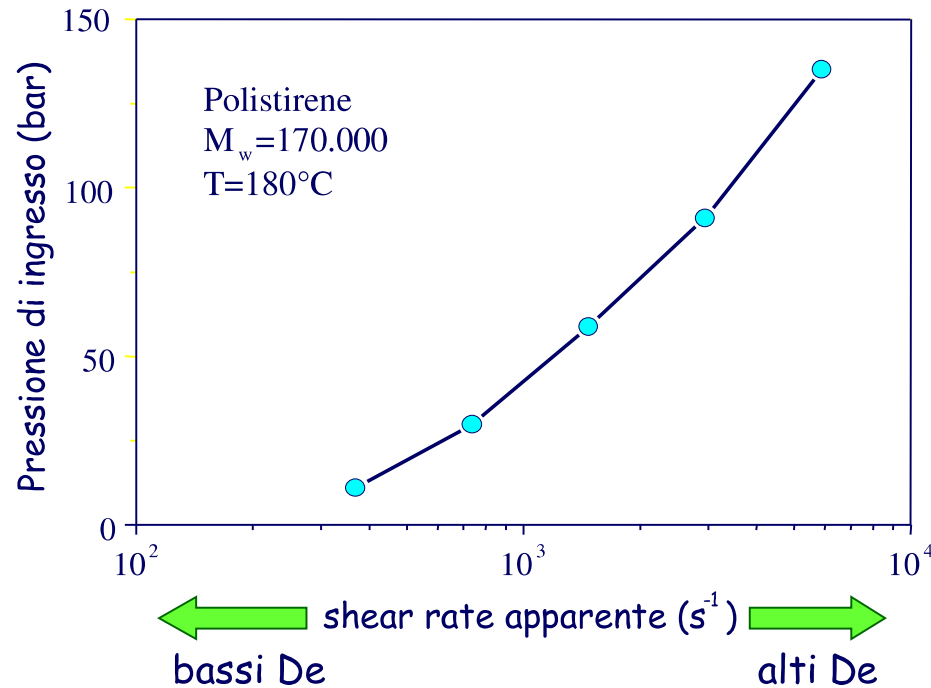

+ La melt fracture aumenta all'aumentare della shear rate

copolimero SIS a 120°C

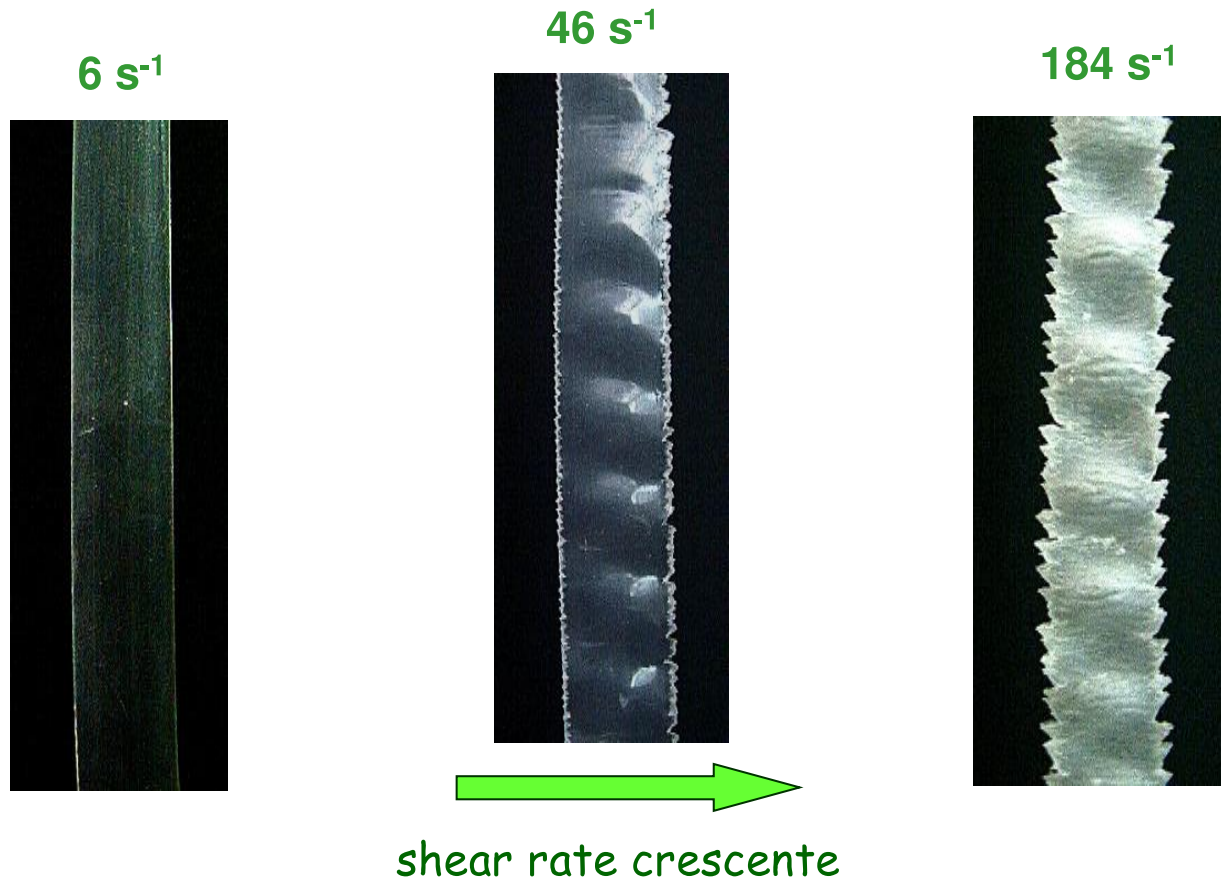

+ Comportamento reologico di sistemi polimerici multifasici

- Alcuni tipi di sistemi multifase:
 - polimeri rinforzati con cariche minerali o fibre
 - polimeri tenacizzati con fase gommosa dispersa
 - blend immiscibili
 - copolimeri a blocchi
 - schiume
- Variabili che influenzano la reologia di sistemi multifase:
 - Quantità di fase dispersa
 - media e distribuzione delle dimensioni particelle
 - fattore di forma delle particelle
 - distanza inter-particellare media
 - deformabilità della fase dispersa



+ Un importante effetto della fase dispersa: lo yield stress

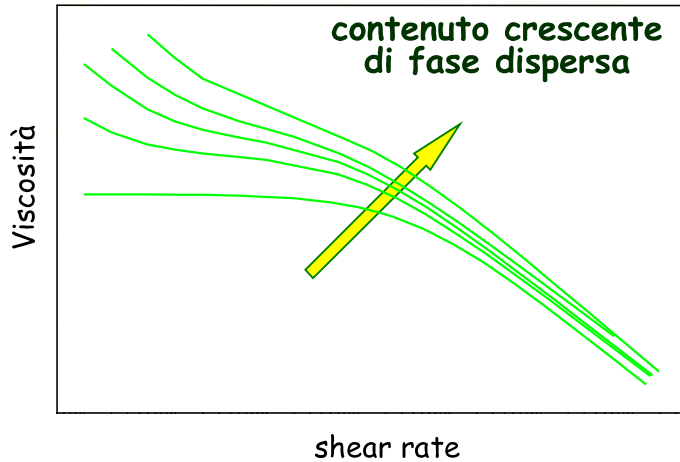

a basse shear rate scompare il plateau newtoniano

C.Y. Ma, J.L. White, F.C. Weissert, K. Min, *SPE Tech. Papers*,31 (1985)

la presenza di yield stress è meglio evidenziata in un grafico viscosità-sforzo

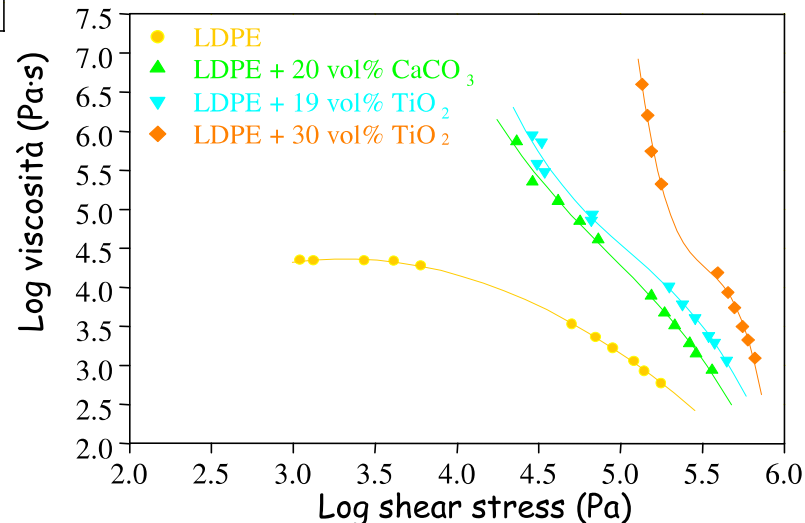

+ polimeri con fase gommosa (reticolata) dispersa

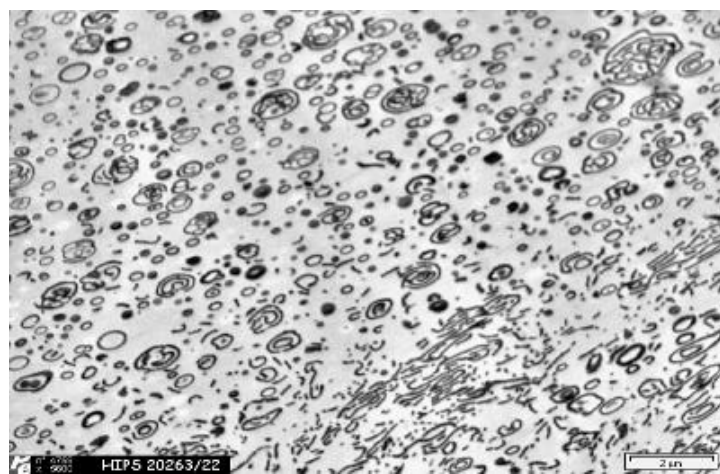
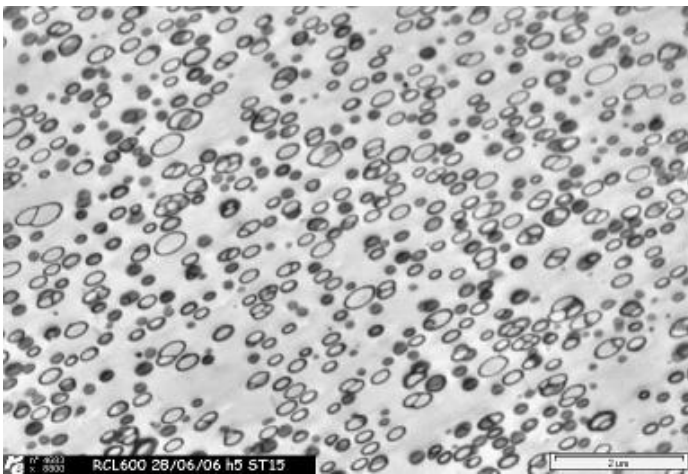
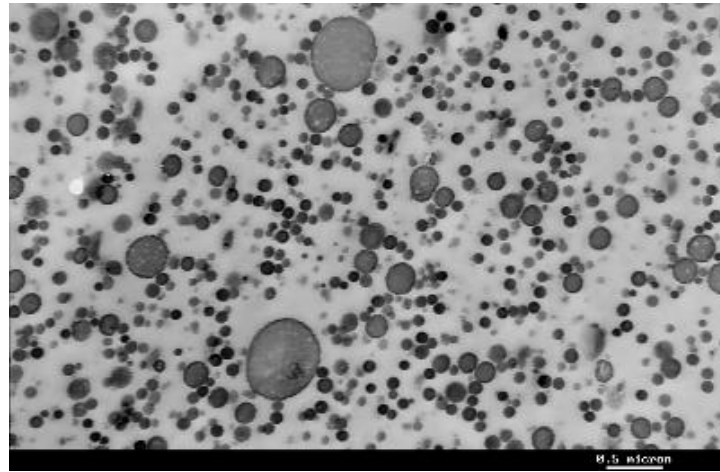
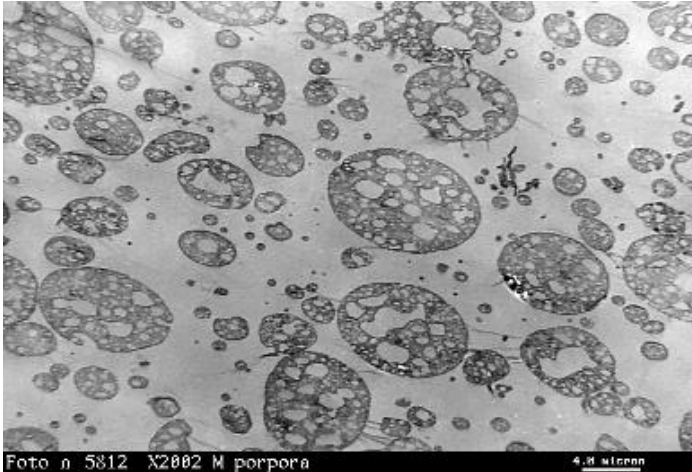

The Rep Rap Project

OPEN 3D PRINTING

+ Open 3D printing: the RepRap project

- RepRap is first general-purpose self-replicating manufacturing machine.
- RepRap takes the form of a free desktop 3D printer capable of printing plastic objects.
- Since many parts of RepRap are made from plastic and RepRap prints those parts, RepRap self-replicates by making a kit of itself - a kit that anyone can assemble given time and materials.



+ The RepRap Project

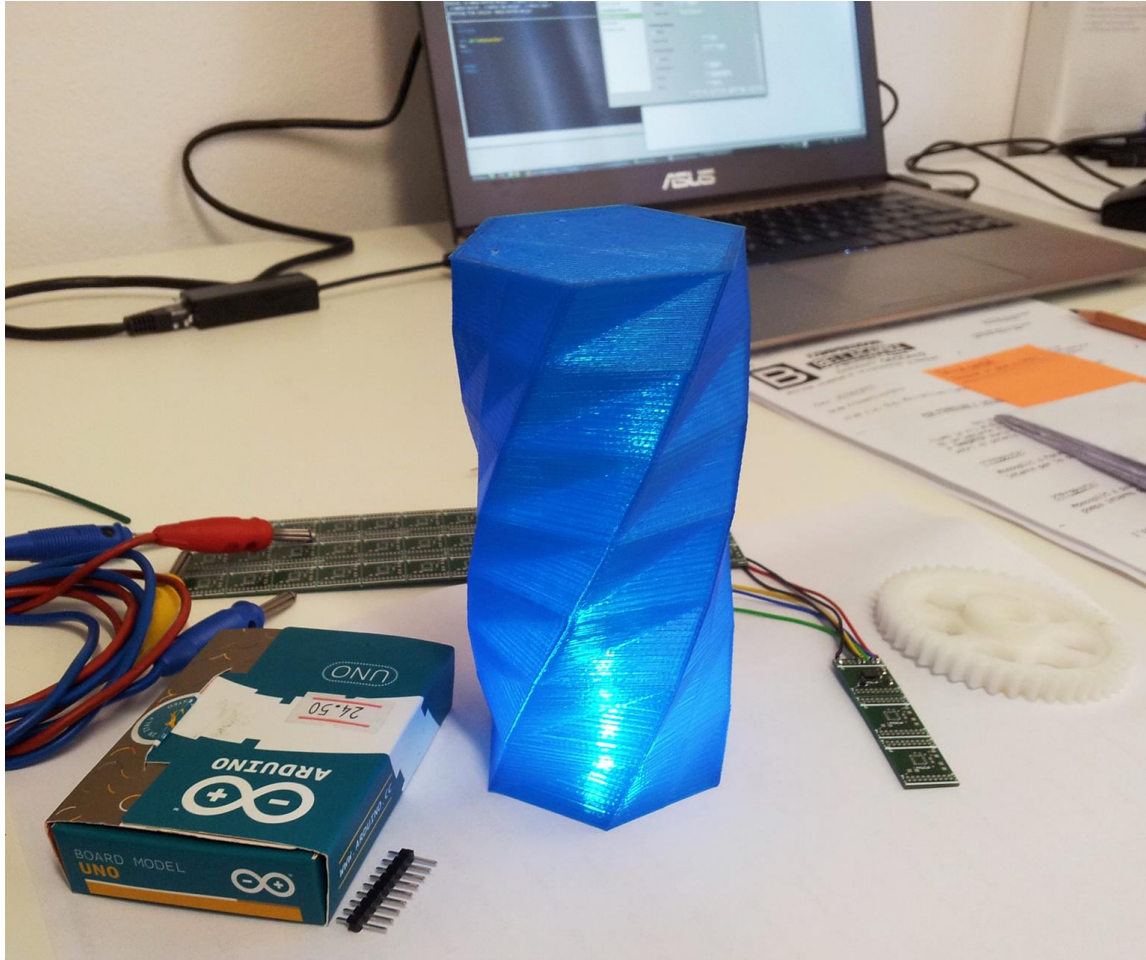

+ The RepRap Project



Which printers (which manufacturer) have you used?

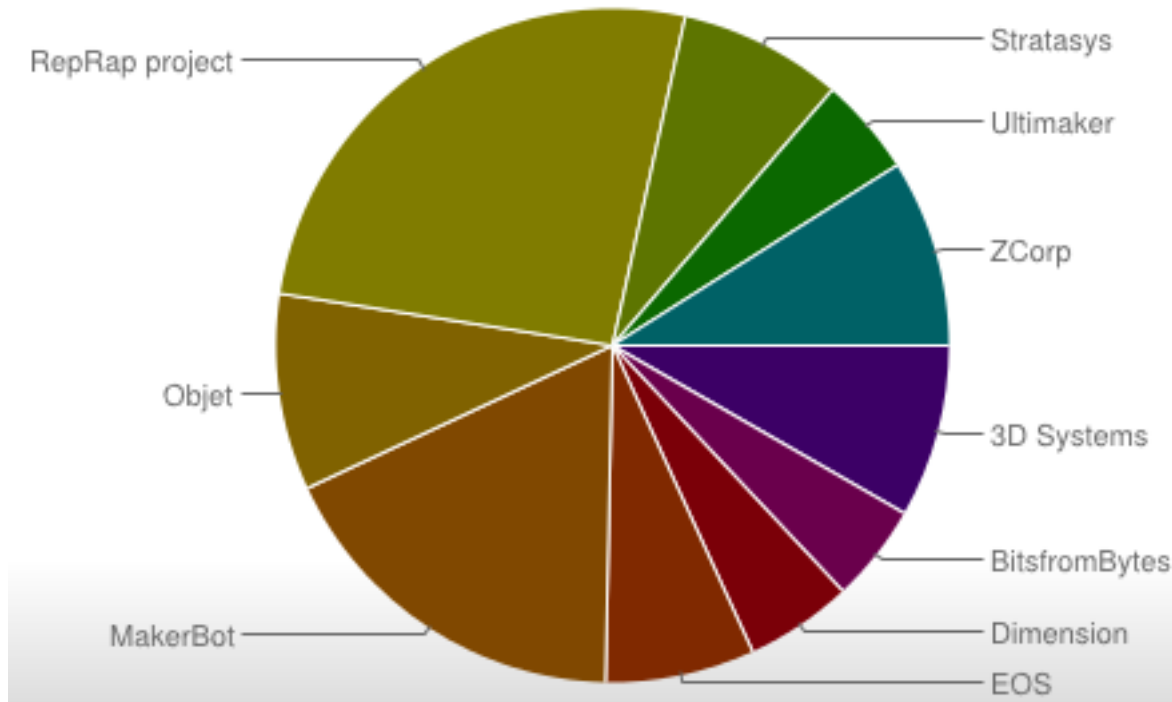

+ The RepRap Project

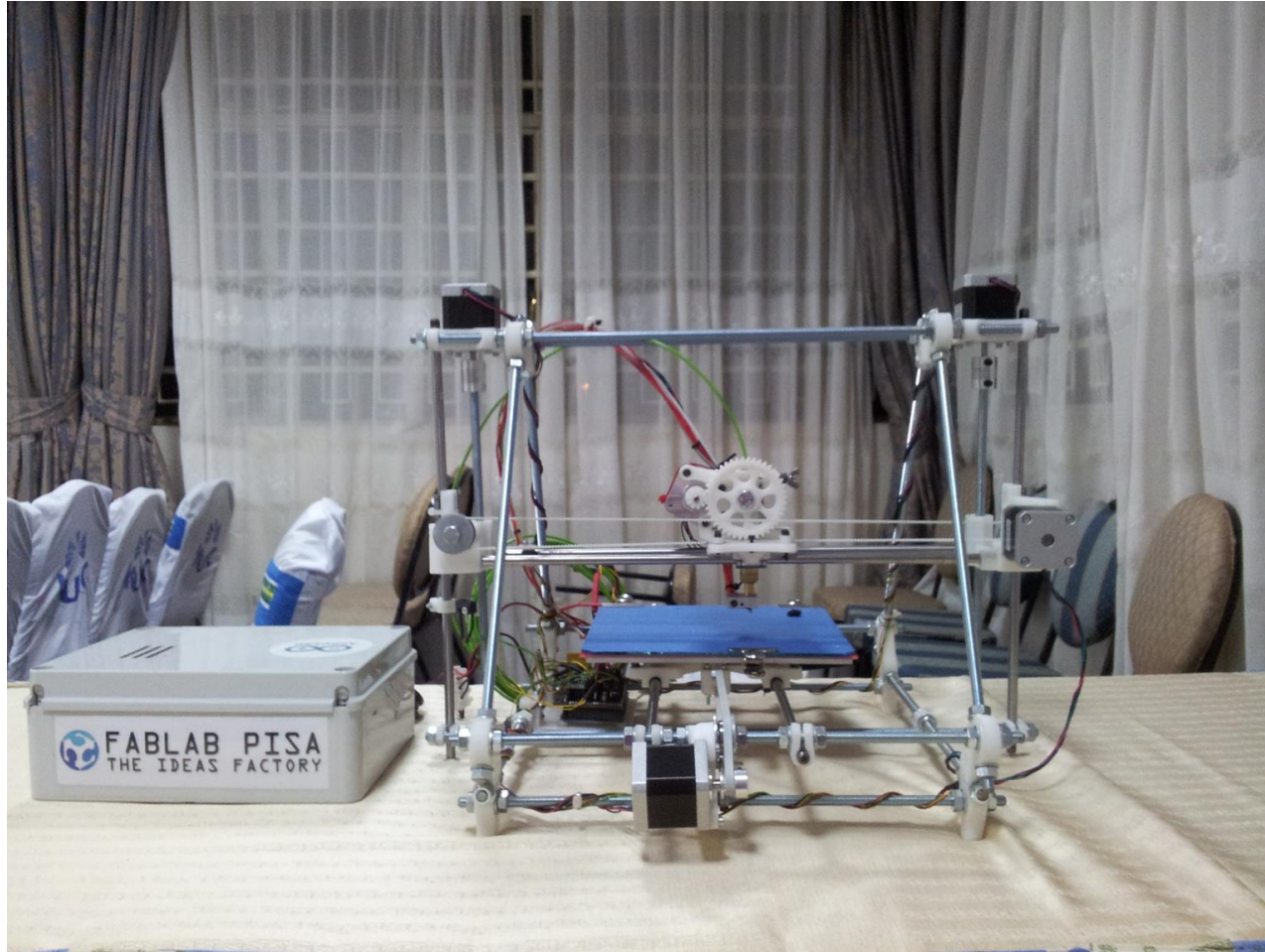

+ The RepRap Project

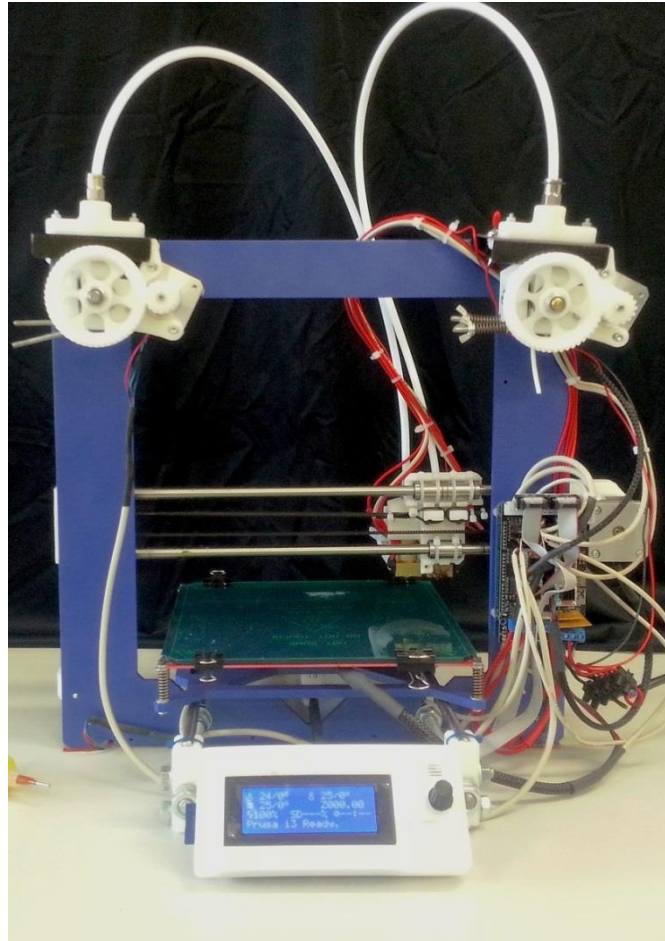

+ How many RepRaps?



Prusa (*license: GPL*)

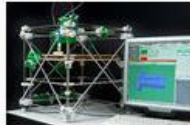

Darwin (*license: GPL*)

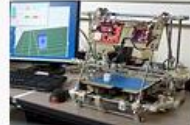

Mendel (*license: GPL*)



Huxley (*license: GPL*)



RepRap Morgan (*license: GPL*)

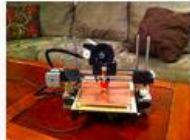

Printbot (*license: CC-BY-SA*)



Cartesio (*license: CC-BY-SA*)



RepRapPro Mendel (*license: GPL*)



RepRapPro Huxley (*license: GPL*)



Eventorbot (*license: CC-BY-SA*)



3drag (*license: CC-BY-SA*)

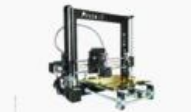

Prusa i3 Rework Introduction (*license: GPL*)

+ Open question

- Which are the Intellectual Property Implications of Low-Cost 3D Printing?
- Is the Open Source 3-D printing an enabling technology for self-directed sustainable development?



A LOOK INTO SLICING PARAMETERS

+ Cura

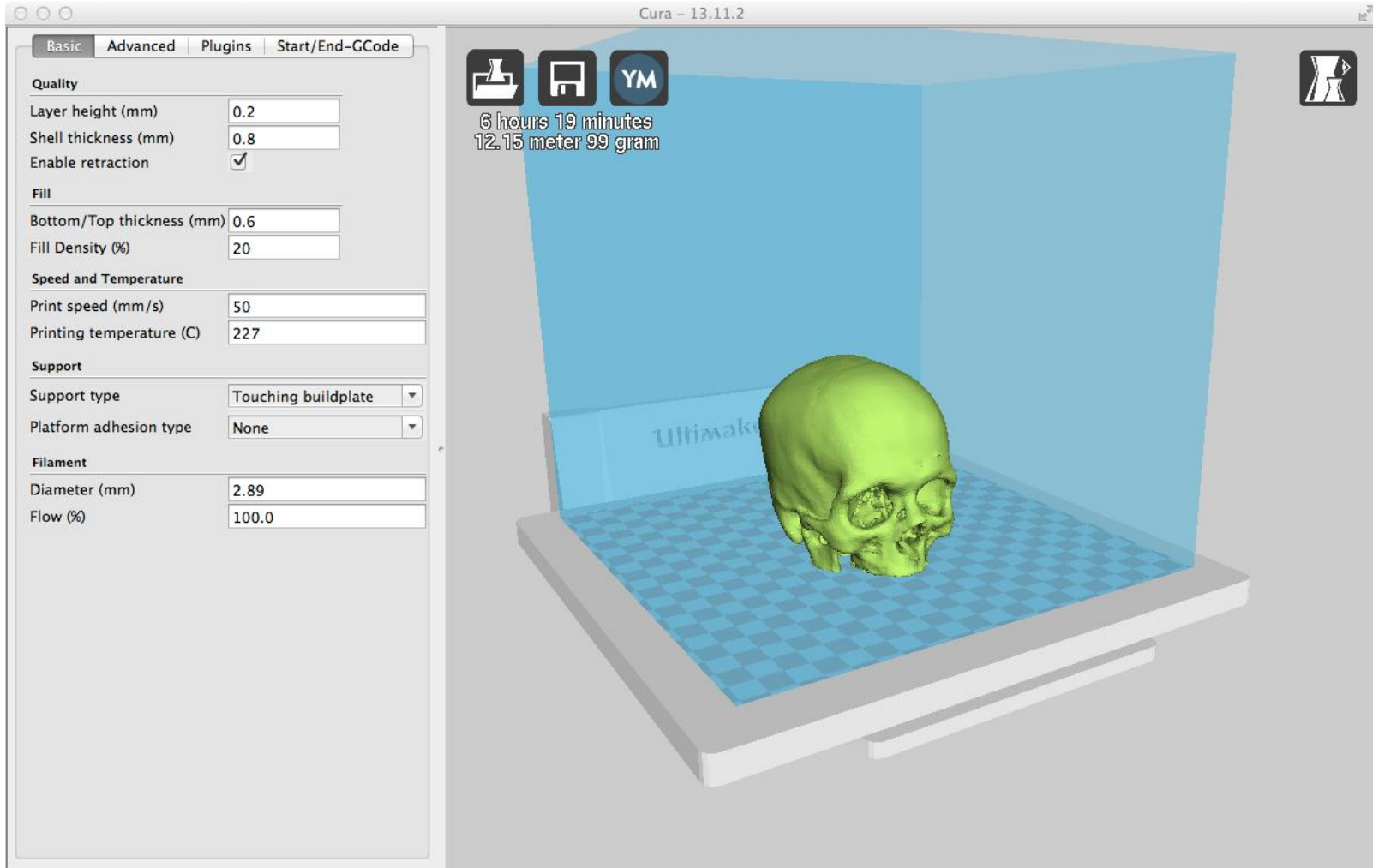

+ Slic3r

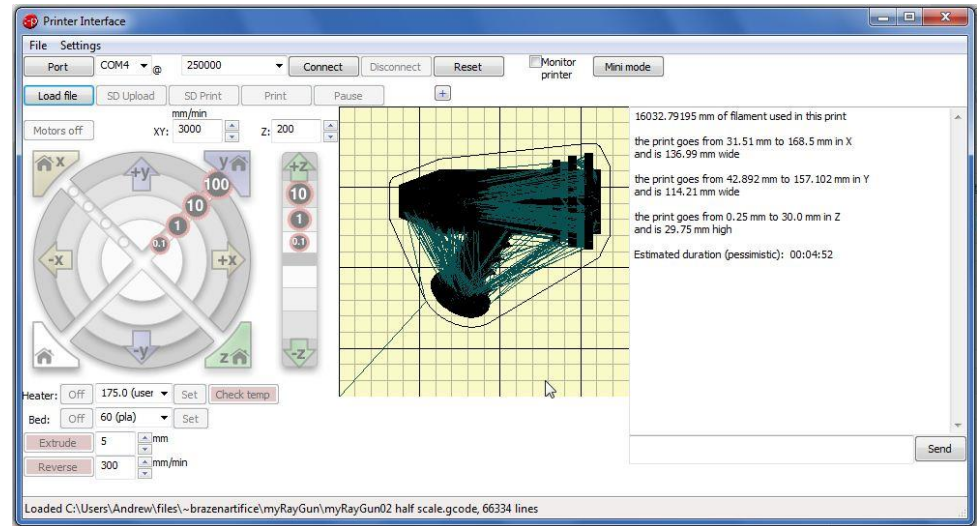

+ Stratasys Catalyst

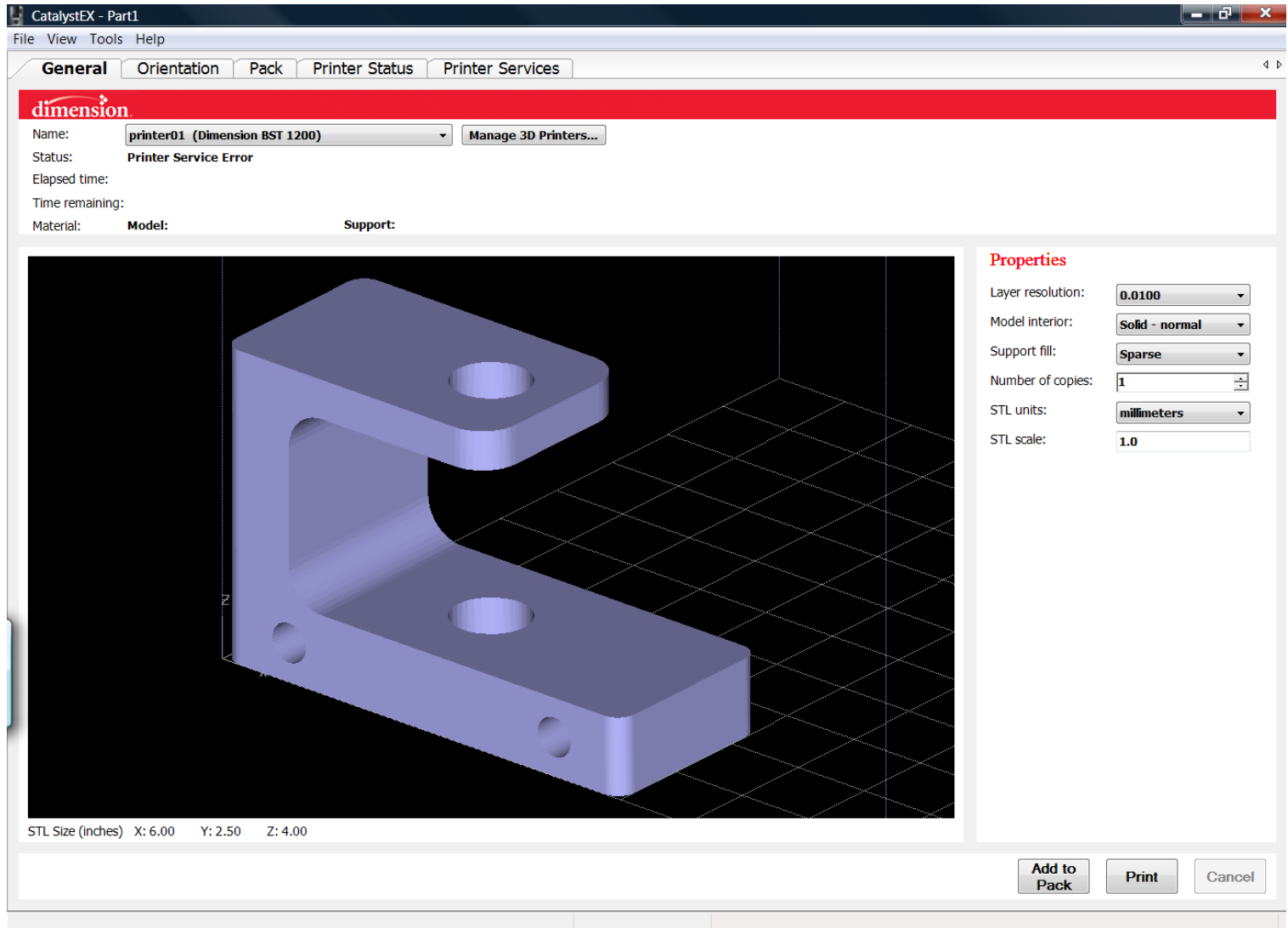

+ Stratasy's Catalyst

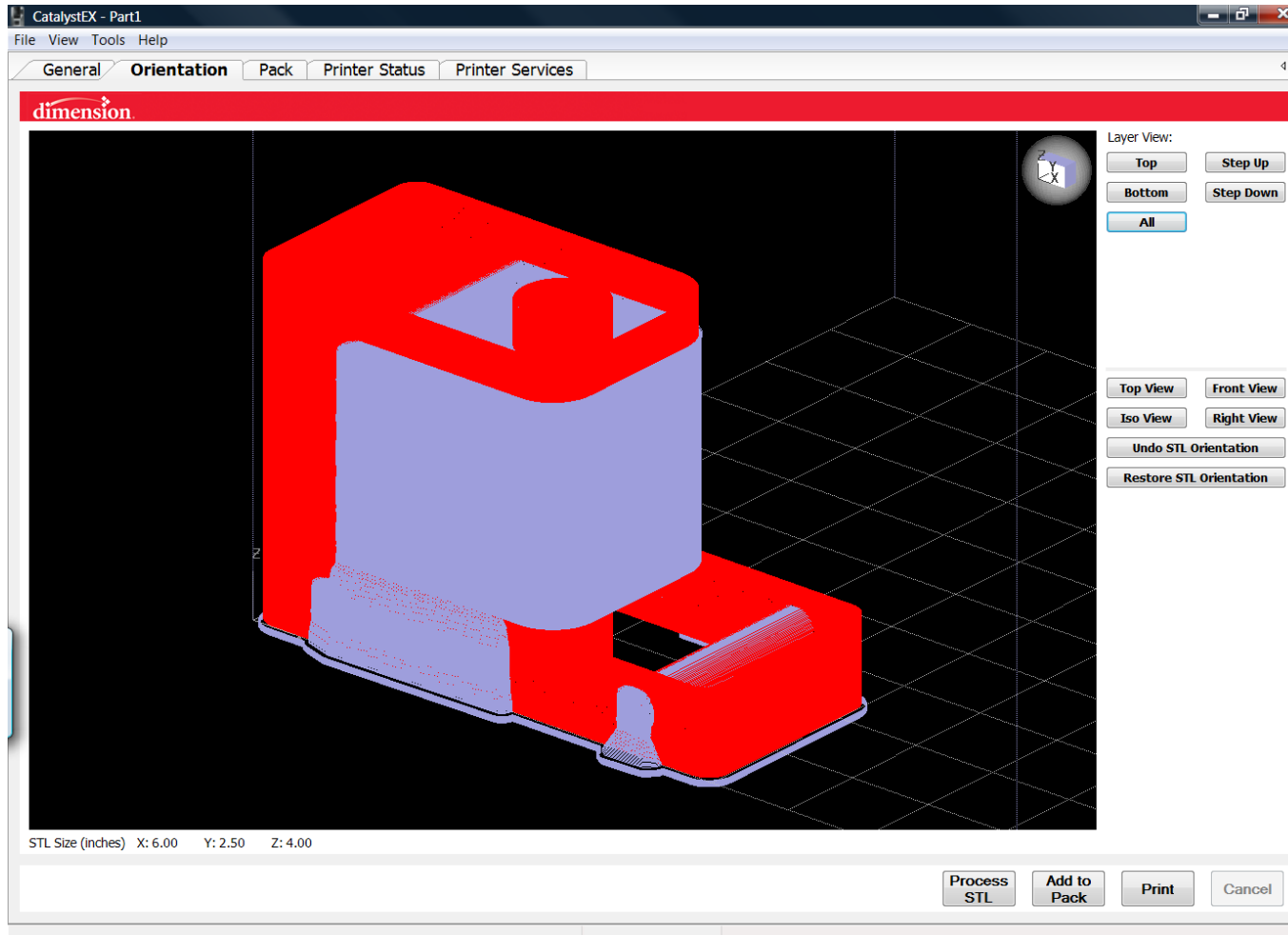

ANATOMY OF A 3D PRINTING SYSTEM

+ Main components of a 3D printer system



Software
(CAD/CAM)

Firmware
(Electronic)

Hardware
extruder

Case study

THE PRUSA I3 REWORK

+ Mechanical structure



Hardware

+ Mechanical structure

	Single Sheet Frame
Plastic Parts (exc Extruder)	26
Non Printed Parts	337 (approx)
Cost	\$300 – 1000
Controller Electronics	Almost all RepRap controller
Printing Size	200 x 200 x 200
Motors	5 x NEMA 17 Stepper
Frame Material	6 mm Aluminium (or Wood)
Frame Manufacture	Laser Cutter, CNC, Water Jet
Pro	Easy assembling
Con	Specialised tools

+ Mechanical structure

- 3D positioner
- Plastic parts + “vitamins”

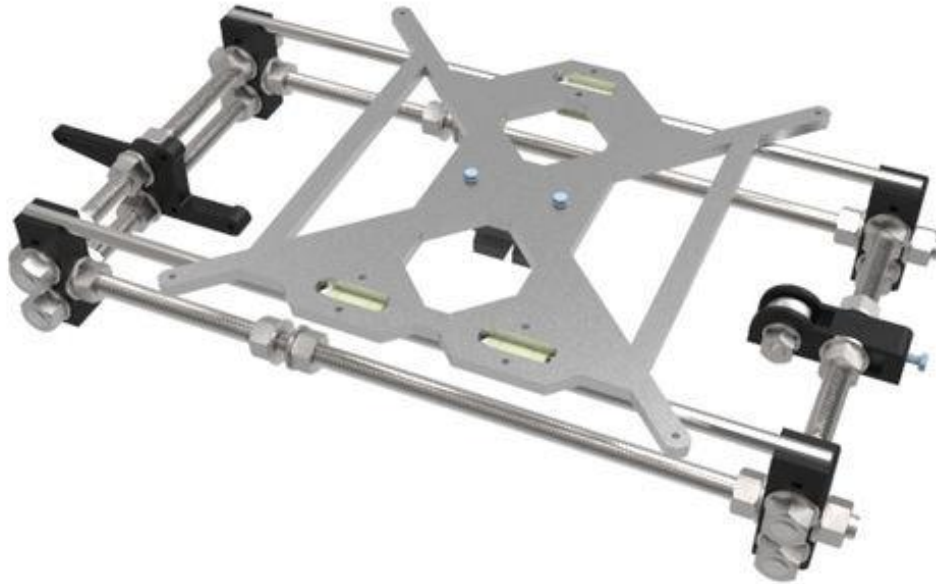

+ Extruder

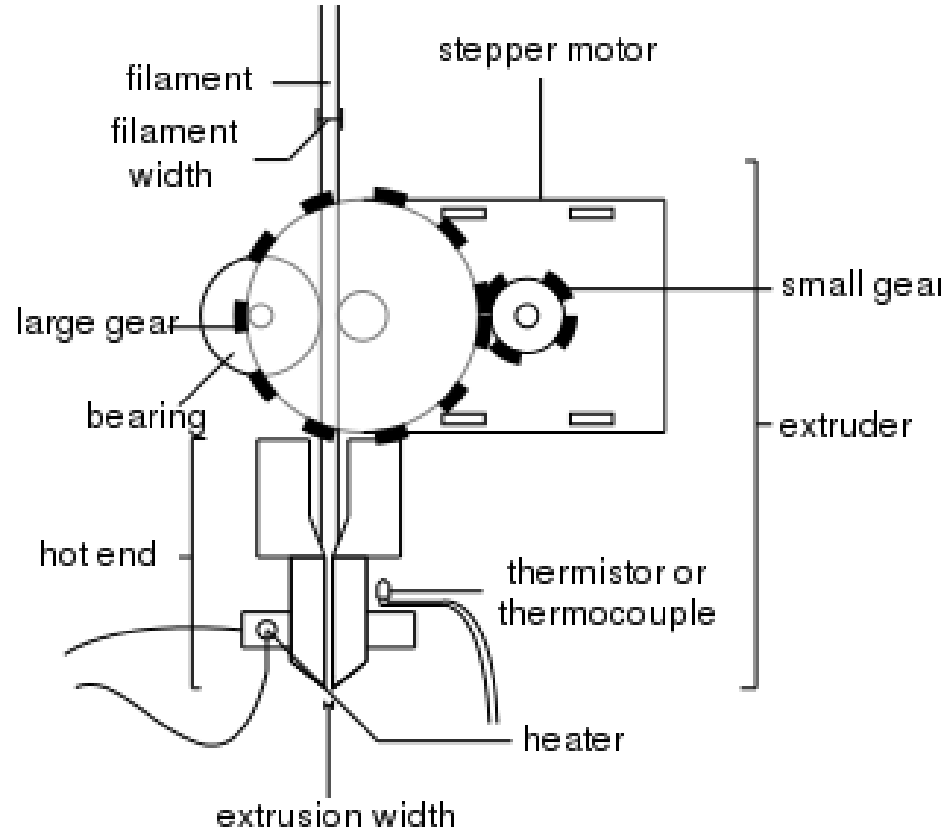

+ Temperature controller

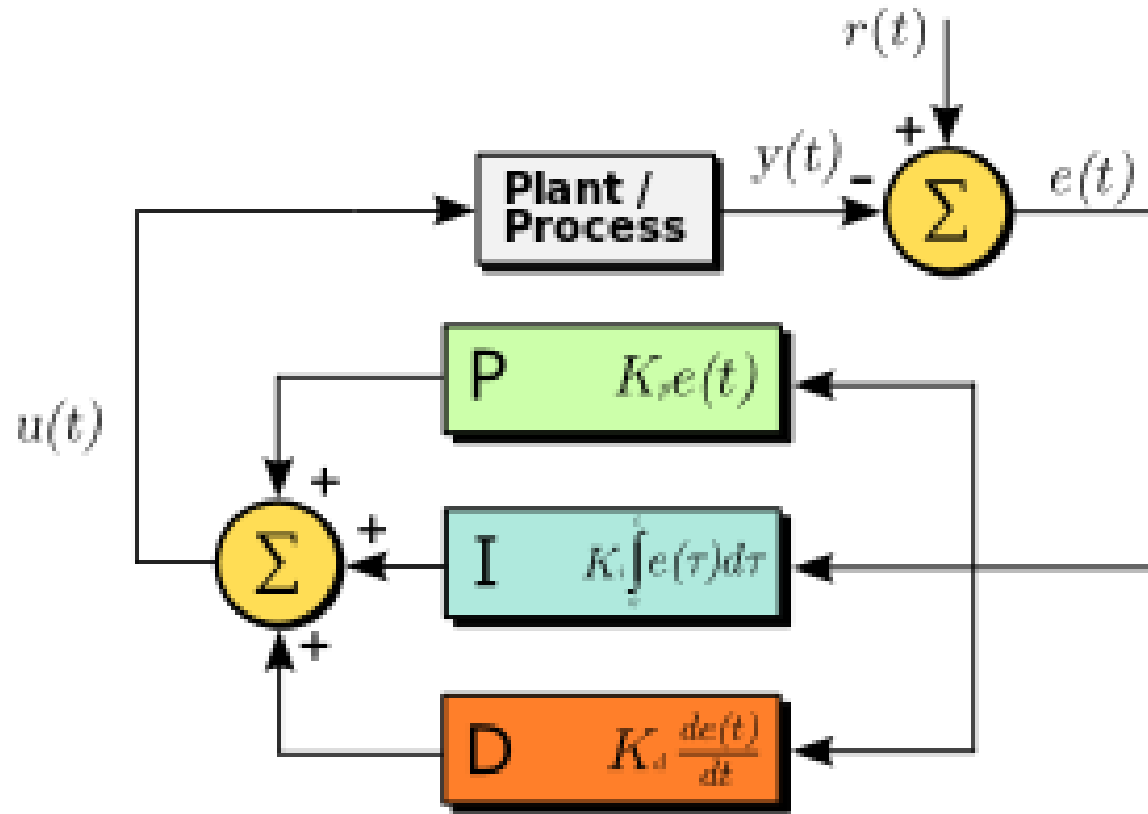

+ HotPlate



Hardware

+ Electronics



- 1) Community based, tested and supported electronics
 - 4pi
 - Generation 7 Electronics
 - Melzi
 - RAMPS (RepRap Arduino Mega Pololu Shield)
 - Sanguinololu
 - SmoothieBoard
- 2) RAMPS derivatives
 - Megatronics
 - 3Drag controller
- 3) Commercial alternatives
 - R2C2 Electronics
 - Generation 6
 - Generation 4

+ Ramps

RepRap Arduino Mega Pololu Shield

ELECTRONICS INFO

Details

Name : RAMPS

Creator : johnnyr

Status : active

Description

Arduino MEGA based modular RepRap electronics.

RAMPS is the most often used RepRap electronics in 2012. It shares circuitry concepts (stepper driver, thermistor, heater MOSFETs, etc.) with many other electronics.

Features

- License=[GPL](#)
- Built on stable Arduino Mega base
- Modular - easier to troubleshoot
- ATmega based
- up to 1/16 microstepping
- etch resist prepared up to v1.3, v1.4 is optimized for smd

Compatible Firmware

- [Marlin](#)
- [Sprinter](#)
- [Teacup](#)



Firmware
(Electronic)

+ RAMPS GADGETS3D Shield with Panel

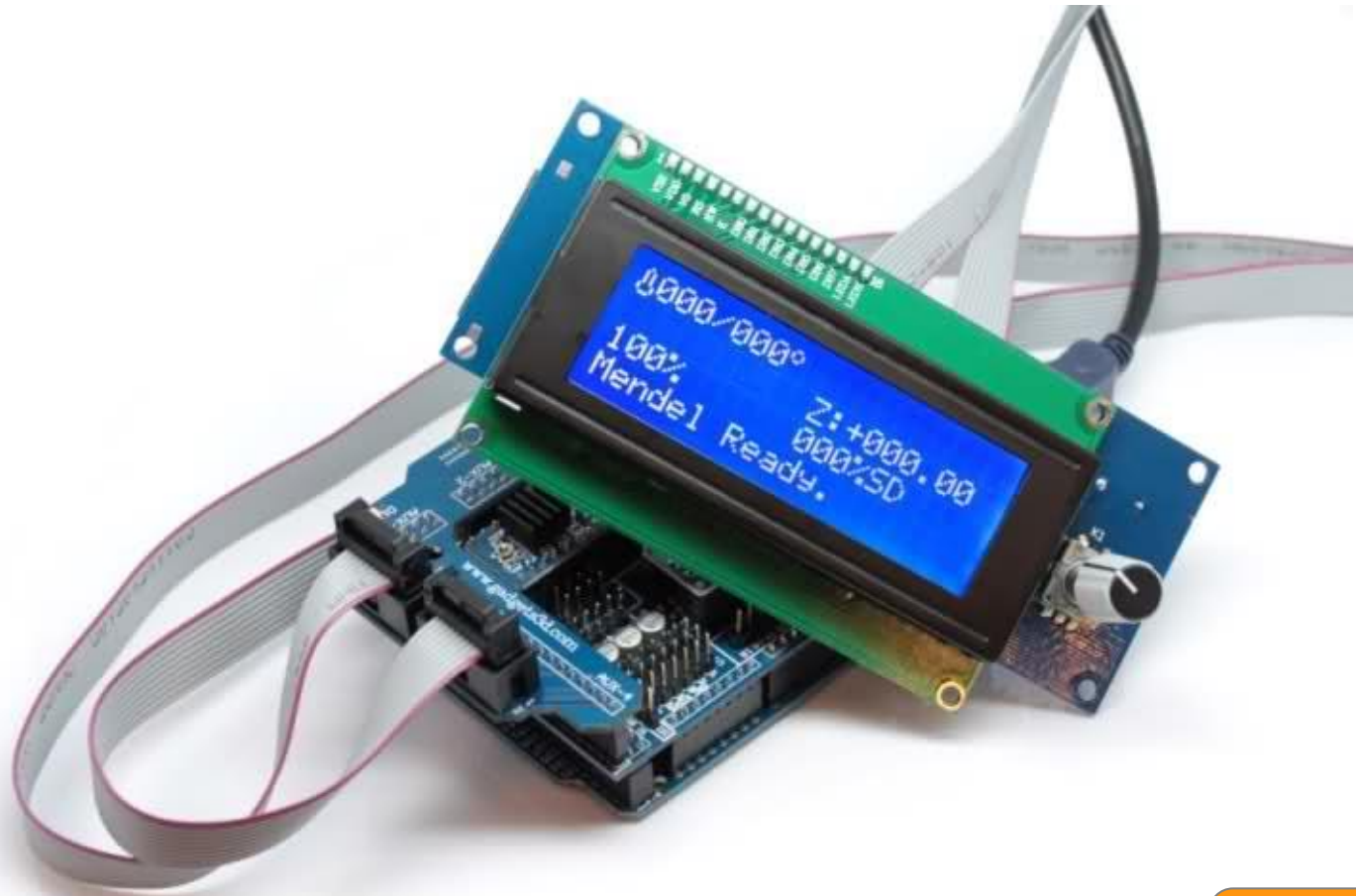

Firmware
(Electronic)

+ Stepper Motors



Stepper motor
(NEMA standard)

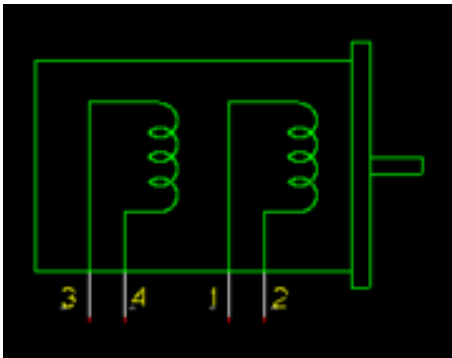

Bipolar

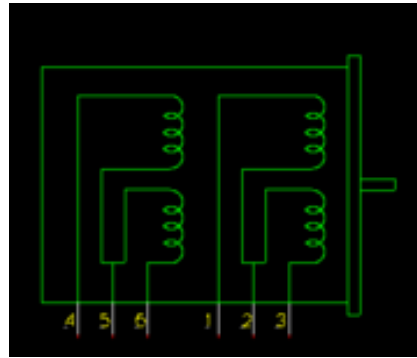

Unipolar



Pololu stepper driver

Firmware
(Electronic)

+ Mechanical Endstops

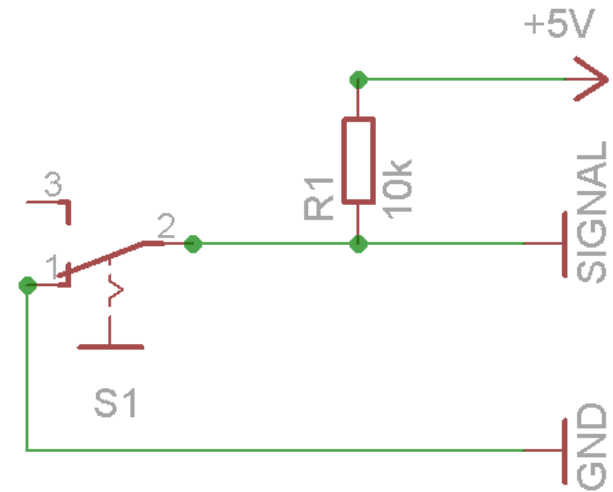

Firmware
(Electronic)

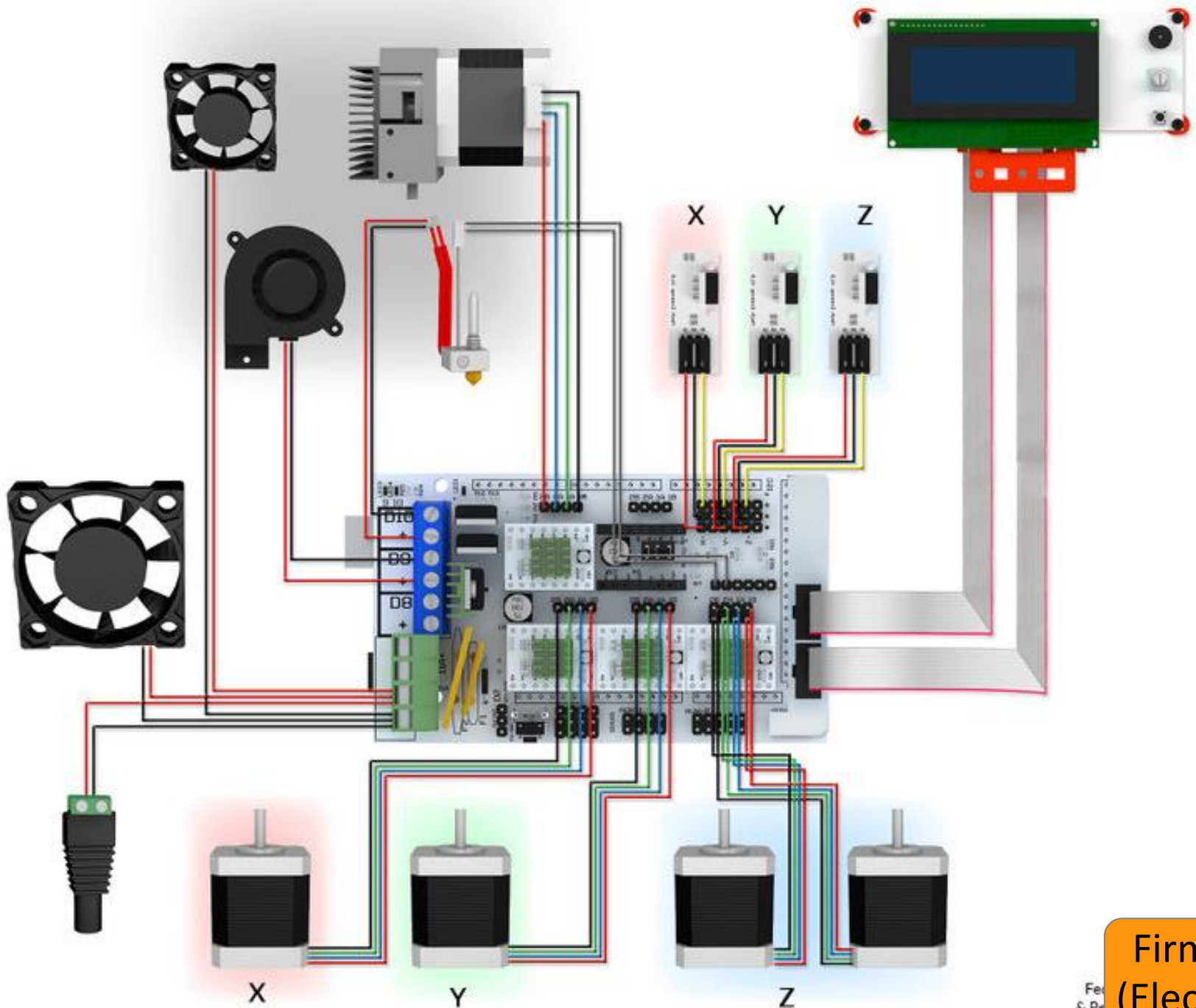

Firmware
(Electronic)

Fer
& Pe

+ Arduino



- Buy
- Download
- Getting Started
- Learning
- Reference
- Products
- FAQ
- Contact Us

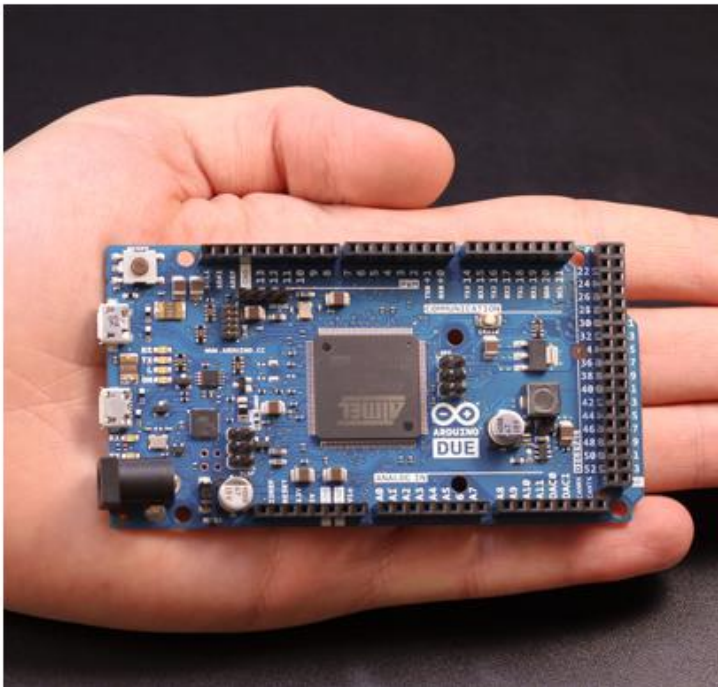

Arduino is an open-source electronics prototyping platform based on flexible, easy-to-use hardware and software. It's intended for artists, designers, hobbyists and anyone interested in creating interactive objects or environments.

Arduino can sense the environment by receiving input from a variety of sensors and can affect its surroundings by controlling lights, motors, and other actuators. The microcontroller on the board is programmed using the [Arduino programming language](#) (based on [Wiring](#)) and the [Arduino development environment](#) (based on [Processing](#)). Arduino projects can be stand-alone or they can communicate with software running on a computer (e.g. [Flash](#), [Processing](#), [MaxMSP](#)).

Firmware
(Electronic)

+ Arduino

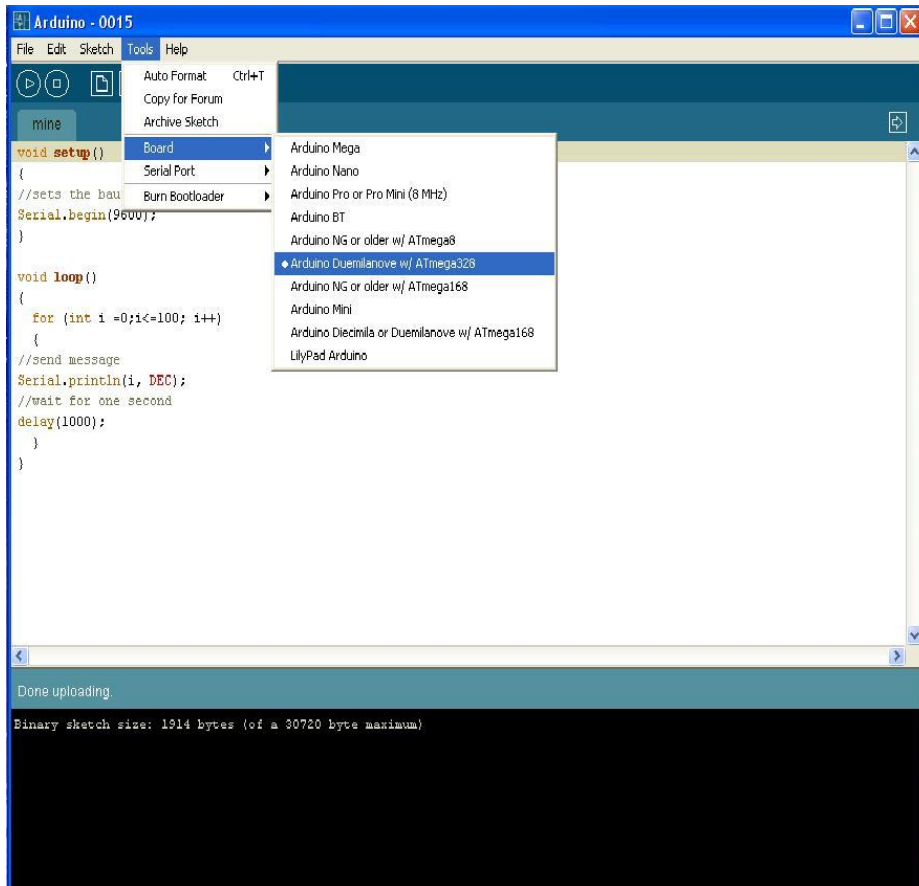

- IDE (Integrated Development Environment)
- The Arduino development environment contains a text editor for writing code, a message area, a text console, a toolbar with buttons for common functions, and a series of menus. It connects to the Arduino hardware to upload programs and communicate with them.
- Software written using Arduino are called sketches.

Firmware
(Electronic)

+ Arduino

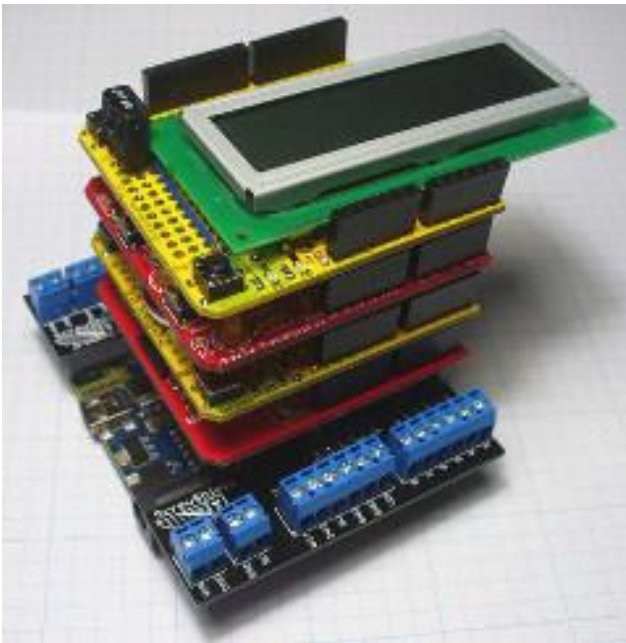

Shields are boards that can be plugged on top of the Arduino PCB extending its capabilities. The different shields follow the same philosophy as the original toolkit: they are easy to mount, and cheap to produce.

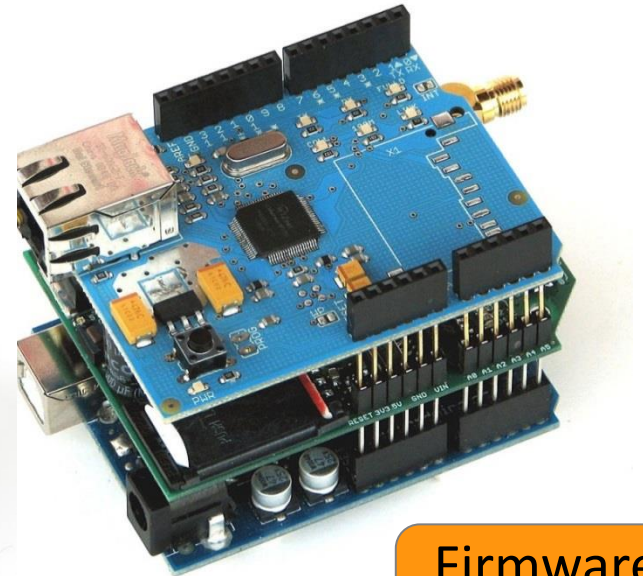
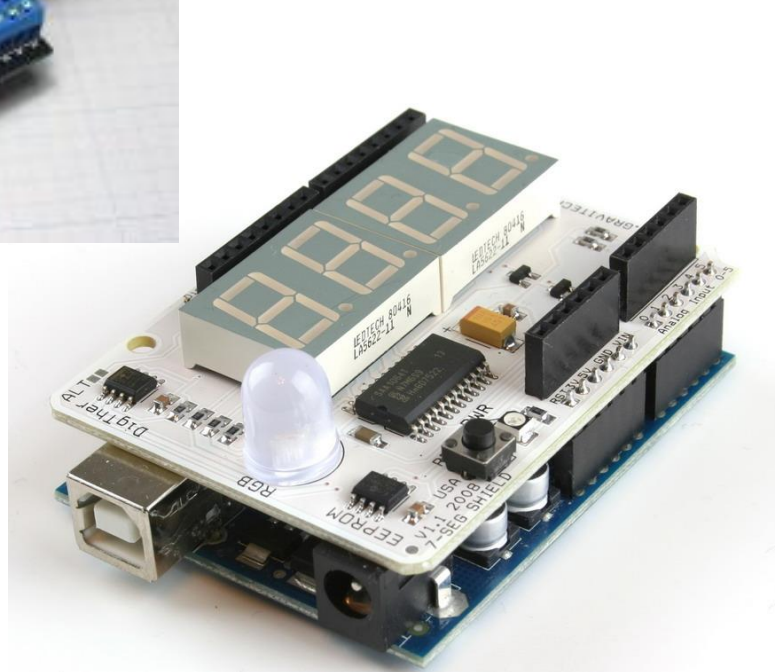

Firmware
(Electronic)

+ Arduino UNO

- The Arduino Uno is a microcontroller board based on the ATmega328.
 - 14 digital input/output pins
 - 6 PWM outputs (8 bit resolution)
 - 6 analog inputs (10 bit resolution)
 - 32 KB Flash Memory (of which 0.5 KB used by bootloader)
 - 2 KB SRAM
 - 1 KB EEPROM
 - 16 MHz ceramic resonator
 - USB connection - ICSP header
 - Power jack - reset button
- It contains everything needed to support the microcontroller
- simply connect it to a computer with a USB cable or power it with a AC-to-DC adapter or battery to get started.



Firmware
(Electronic)

+ Arduino Mega

- The Arduino MEGA is a microcontroller board based on the ATmega2560.
 - 54 digital input/output pins
 - 15 PWM outputs (8 bit resolution)
 - 16 analog inputs (10 bit resolution)
 - 256 KB Flash Memory (of which 8 KB used by bootloader)
 - 8 KB SRAM
 - 4 KB EEPROM
 - 16 MHz ceramic resonator
 - USB connection - ICSP header
 - Power jack - reset button

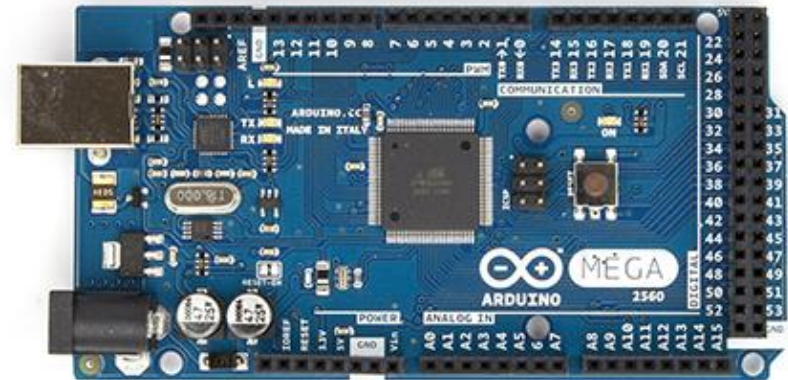

+ Difference between microprocessor and microcontroller

- Microprocessor is an IC which has only the CPU inside them. It doesn't have RAM, ROM, and other peripheral on the chip. Application of microprocessor includes Desktop PC's, Laptops, notepads etc.
- Microcontroller has a CPU, in addition with a fixed amount of RAM, ROM and other peripherals all embedded on a single chip.
- Microcontrollers perform specific tasks where the relationship of input and output is defined.
- Microprocessors find applications where tasks are unspecific like software, games, websites, photo editing
- Microcontroller doesn't have video output.
- Microcontroller are programmed with firmware
- Microprocessors run operating systems on which software applications run.

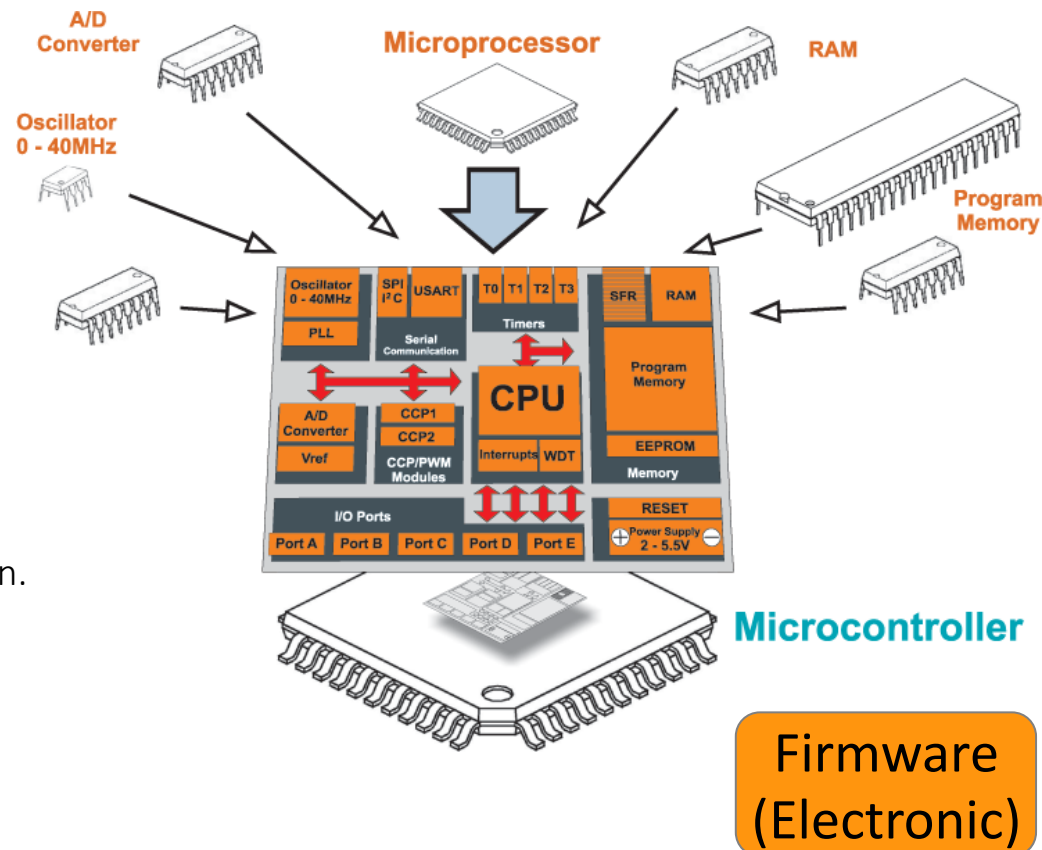

+ Firmwares

- List of firmwares
 1. Sprinter
 2. Teacup
 3. sjfw
 4. Marlin
 5. Sailfish
 6. Makerbot
 7. Grbl
 8. Repetier-Firmware

COMMON PROBLEMS WITH (LOW COST) FDM SYSTEMS

+ Warping

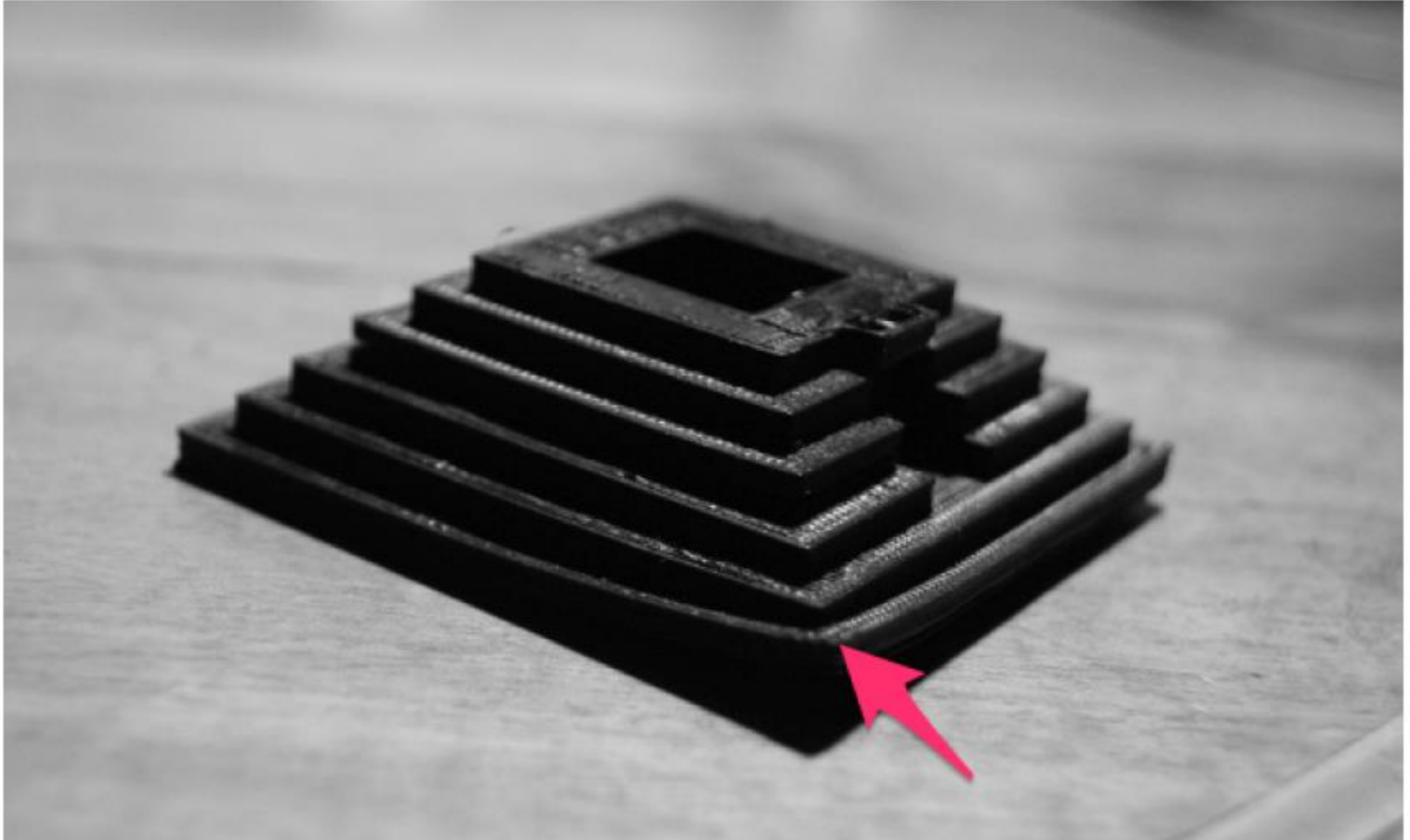

+ Elephant foot

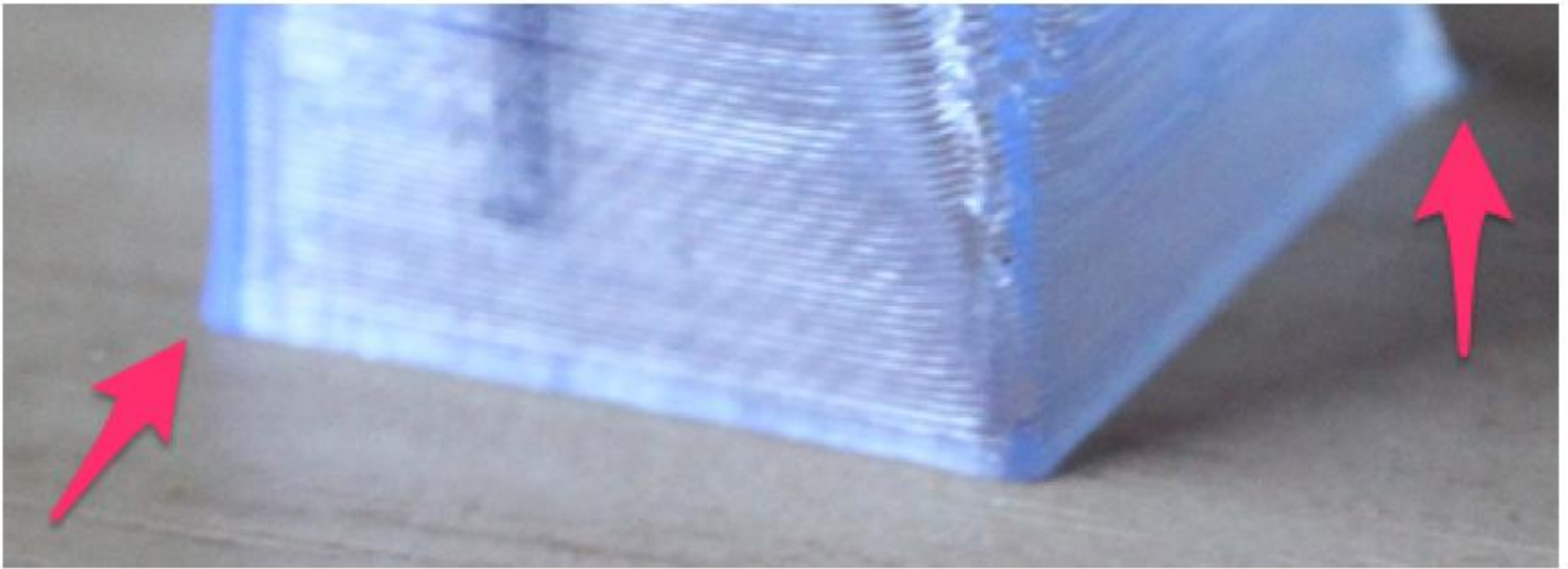

+ Cracks in tall objects

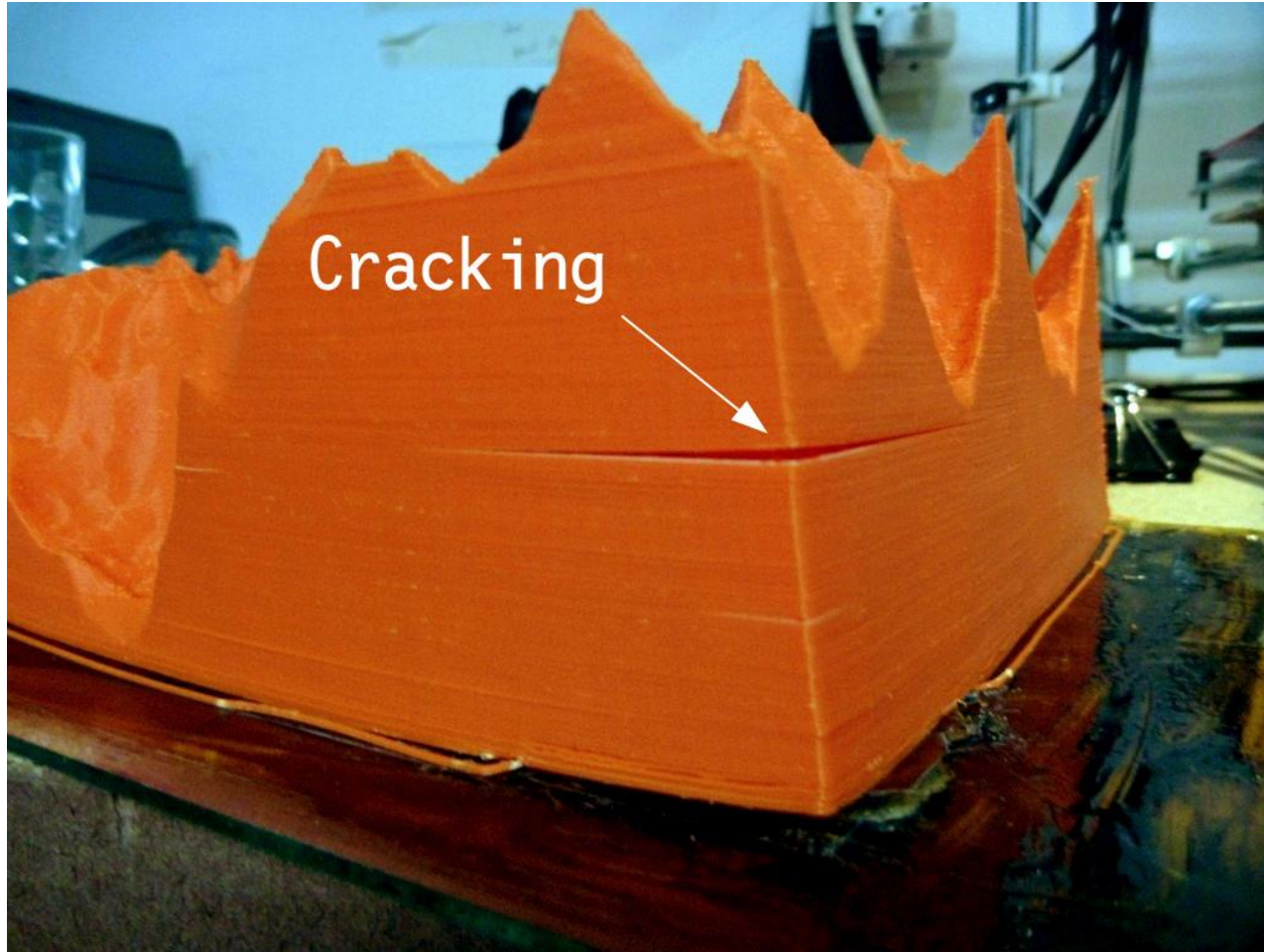

+ Pillowing

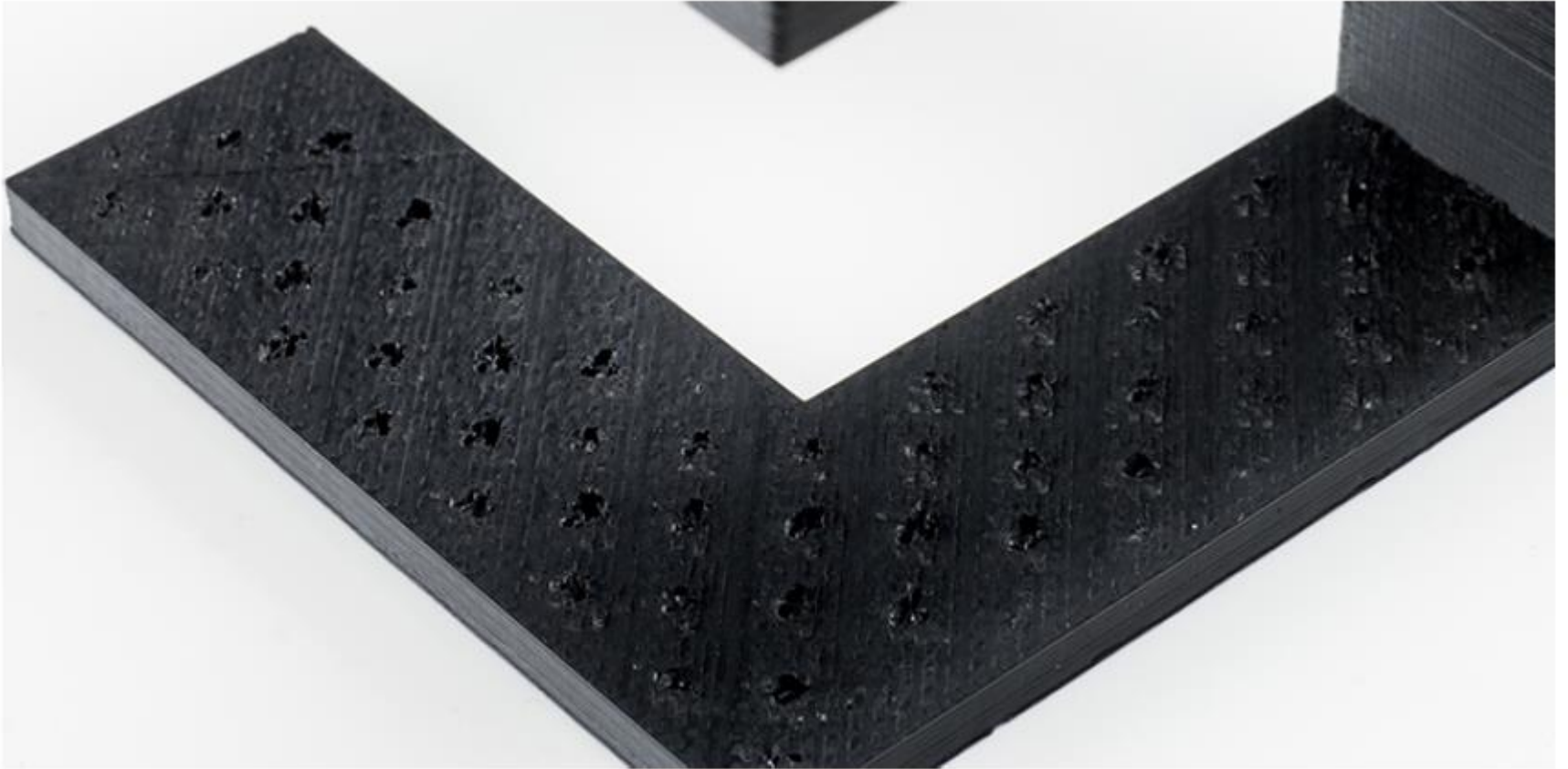

+ Stringing

