

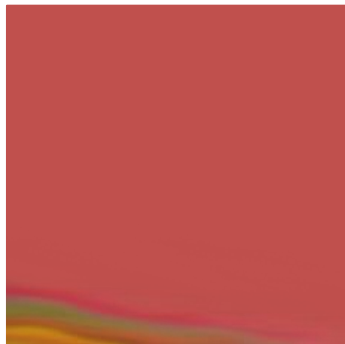

Centro E. Piaggio  
bioengineering and robotics research center

# Software for Additive manufacturing

---

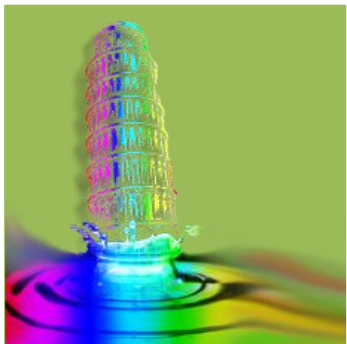
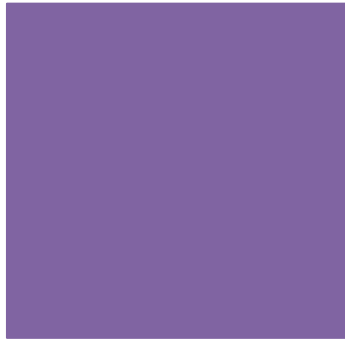

[carmelo.demaria@centropiaggio.unipi.it](mailto:carmelo.demaria@centropiaggio.unipi.it)

# + Additive manufacturing Process Flow

- Solid Modelling
- Tessellation/Generation of STL file
- Support Generation
- “Slicing” of the Model
- Model Physical Buildup
- Cleanup and Post Curing
- Surface Finishing



# + from idea to design

- *Solid modelling*

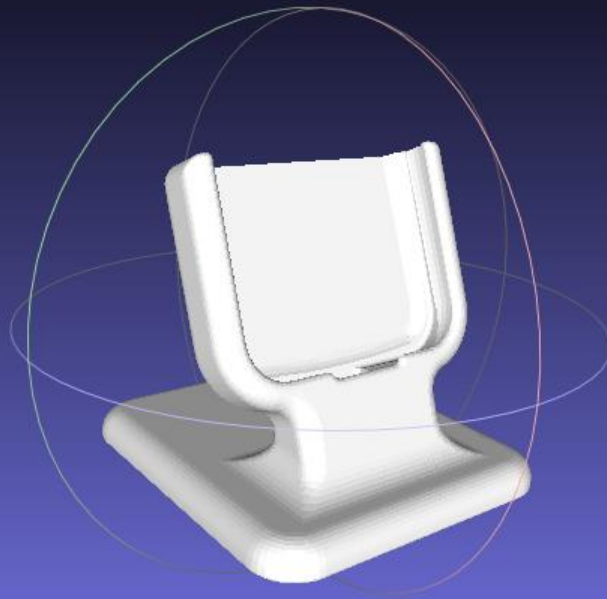

# + from idea to design

- *Tesselation/Generation of STL file*

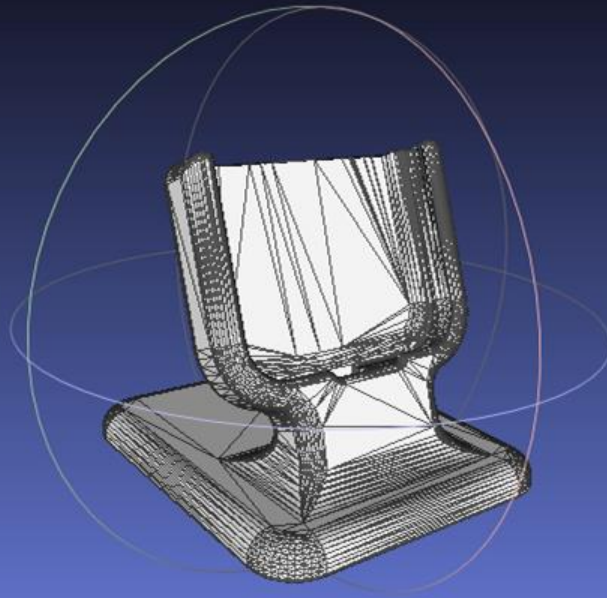

# + from design to object

- *Support generation*
- *“Slicing the model” (GCode, from CAD to CAM)*

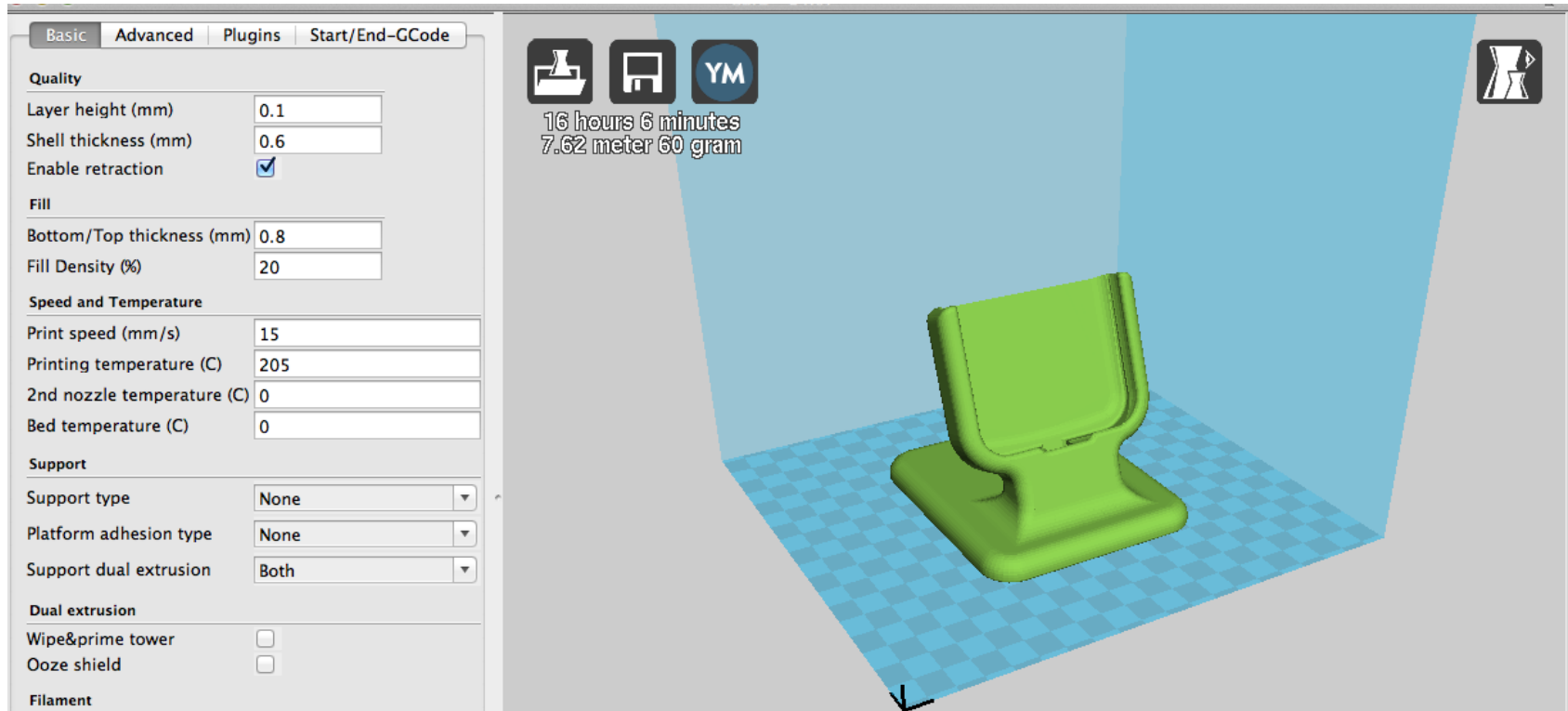

# + from design to object

- *Model physical build-up*

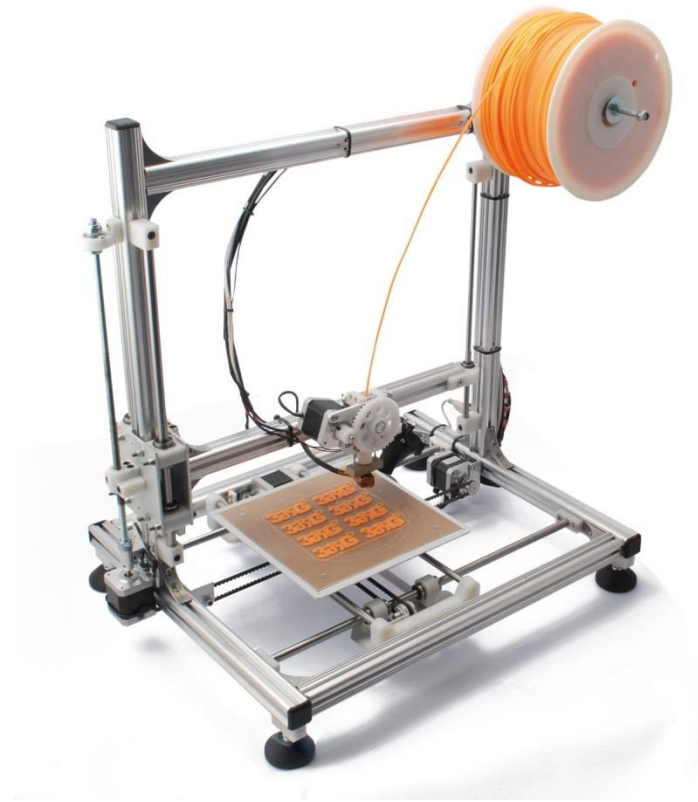

# + from design to object

- *Cleanup and Post Curing*
- *Surface Finishing*



# + Additive manufacturing Process Flow



File



Description



Software





# + Additive manufacturing Process Flow



Image acquisition

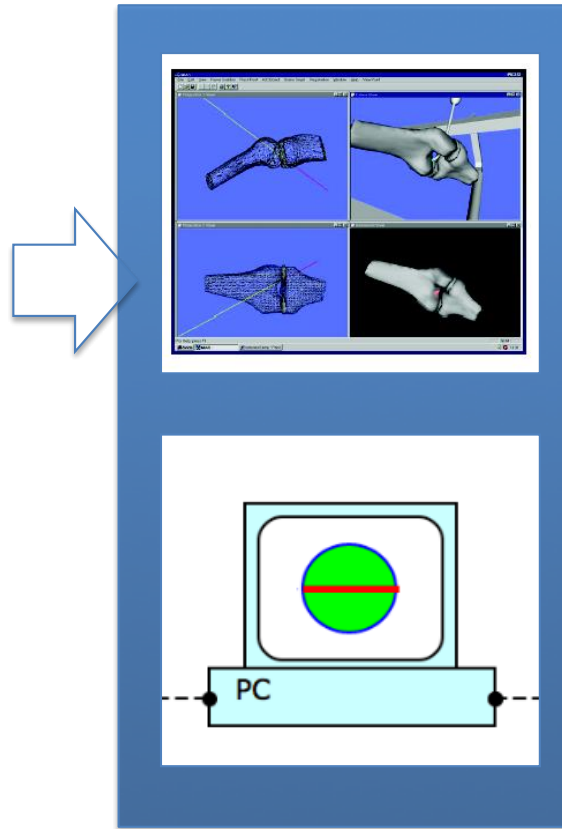

CAD/CAM system

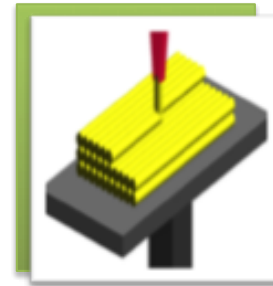

Direct writing

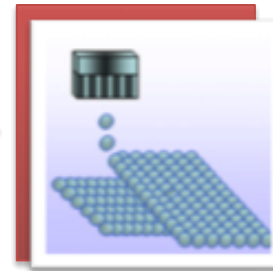

Inkjet based



**DATA SOURCE**

# + Data source

- Representation of a volume
  - CAD model
    - Your specific design
    - Web repository:
      - <http://www.thingiverse.com>, <https://www.youmagine.com>
      - <https://3dprint.nih.gov>
      - <http://www.appropedia.org>, <http://opensourceecology.org>, <http://reprap.org>
  - Instruments output
    - Segmentation of medical Images (Tomographic Data: CT scan, RM scan)
    - Surface scanning
      - Laser
      - Optical (also phone camera, <http://www.meshlab.net>, II semester)



# + CAD Model

Dimensions of CAD Elements	Elements	Type of CAD Model
0D	Point	Corner Model
1D	Line	Edge Model
2D	Surface	Surface Model
3D	Solid/Volume	Solid or Volume Model

- Most of the CAD software are proprietary with a relatively high cost
- Free or Open Source examples
  - FreeCAD (<https://www.freecadweb.org>)
  - TinkerCAD (online <https://www.tinkercad.com>)

# + CAD Model

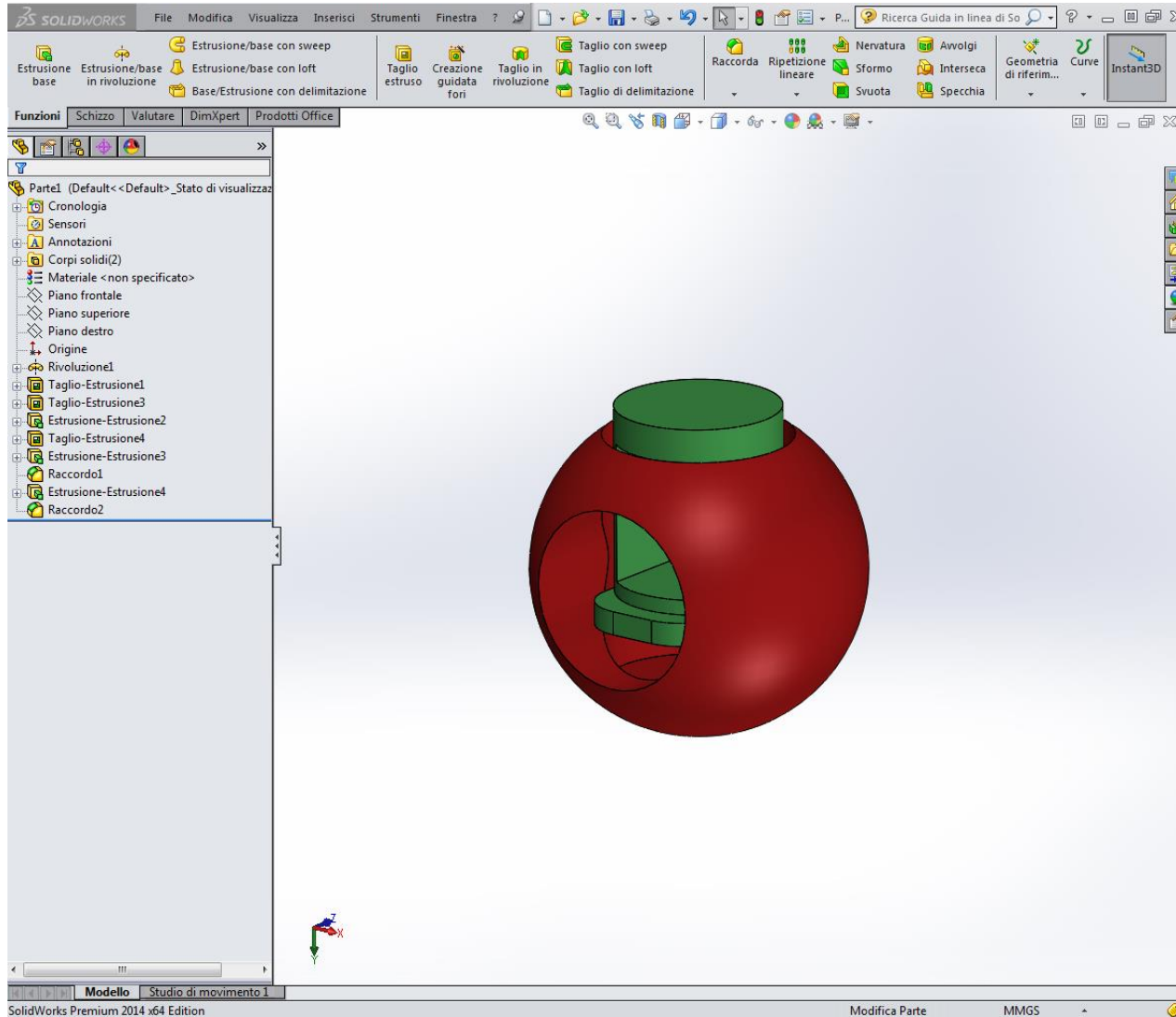

Example 1

# FROM MEDICAL IMAGES TO STL

# + Segmentation

- Segmentation subdivides an image into its constituent regions or objects.
- The level of subdivision depends on the problem being solved

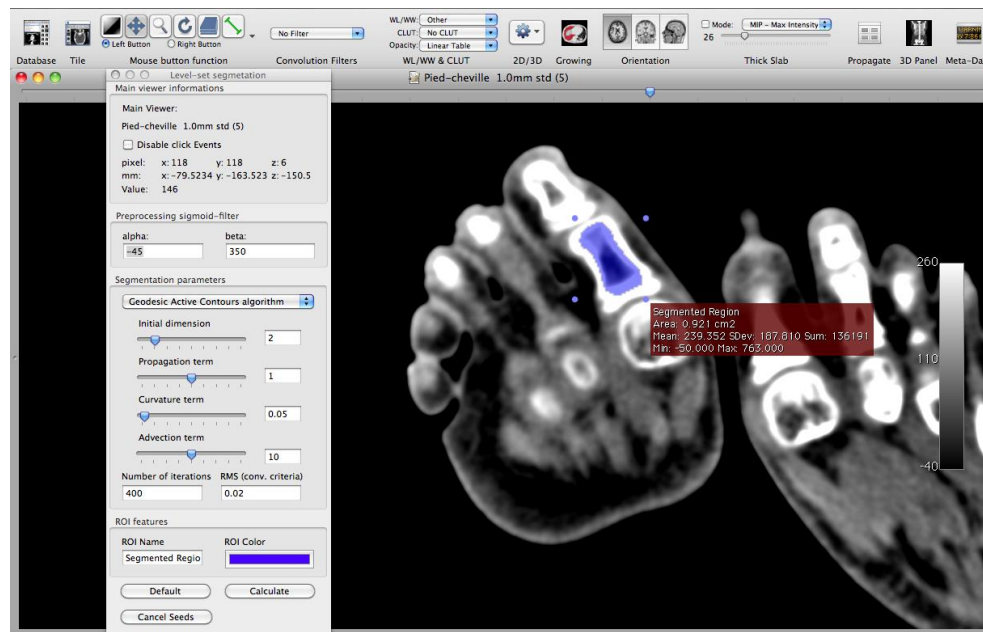

# + Software for image segmentation

- OsiriX ([www.osirix-viewer.com](http://www.osirix-viewer.com))
- 3DSlicer ([www.slicer.org](http://www.slicer.org))
- ImageJ ([rsb.info.nih.gov/ij](http://rsb.info.nih.gov/ij))
- MIPAV ([mipav.cit.nih.gov](http://mipav.cit.nih.gov))
- itk-SNAP ([www.itksnap.org](http://www.itksnap.org))





Use of 123DCatch

# FROM 3D SCAN TO STL



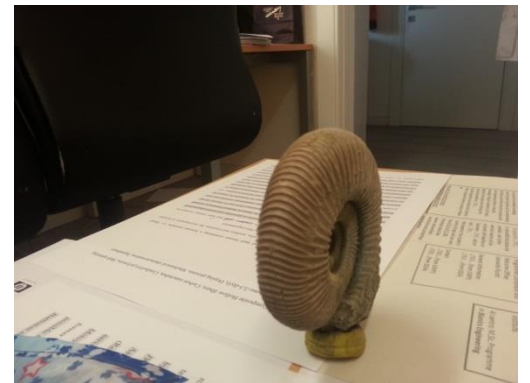

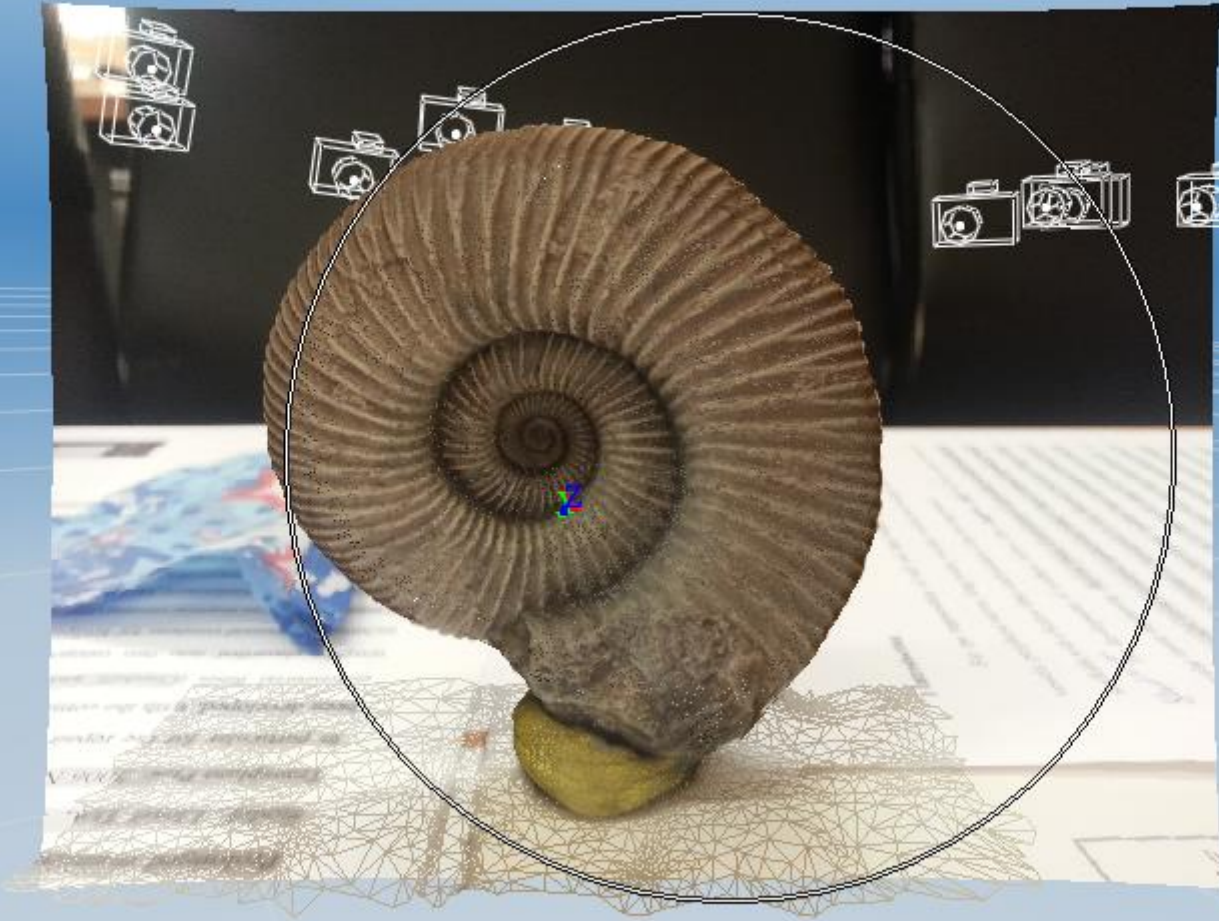



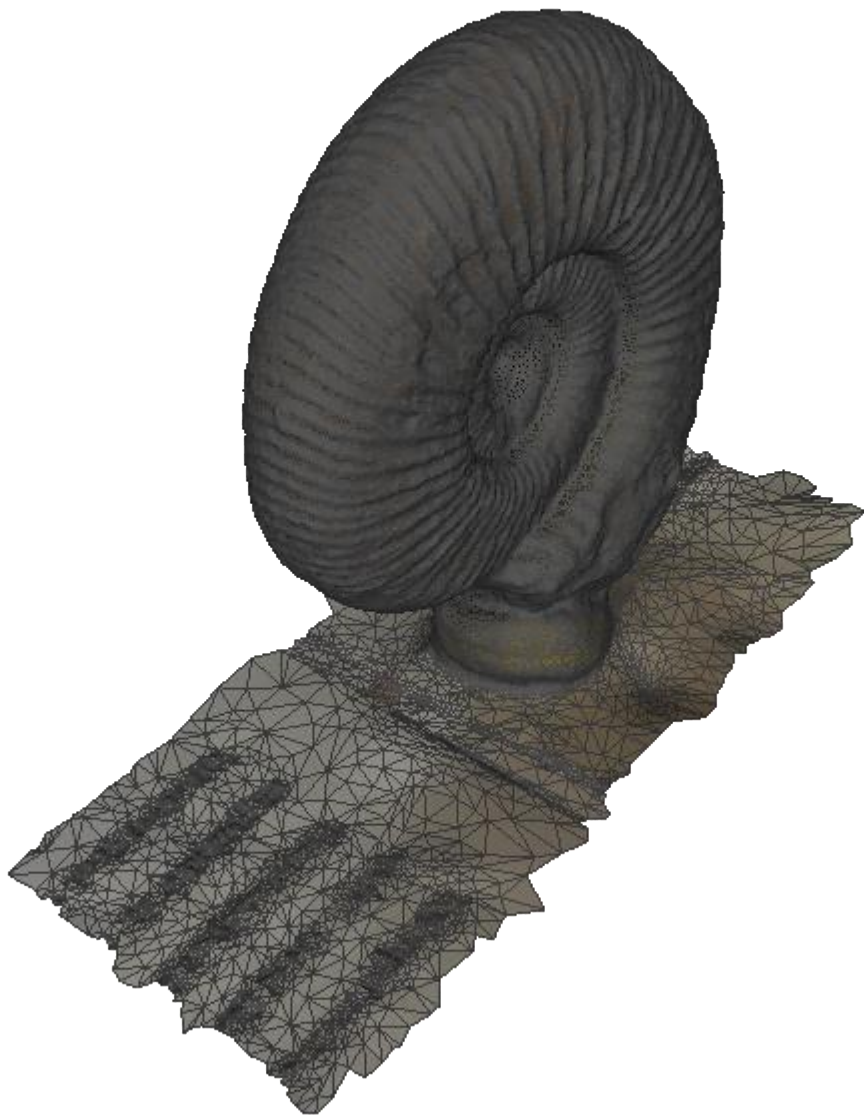

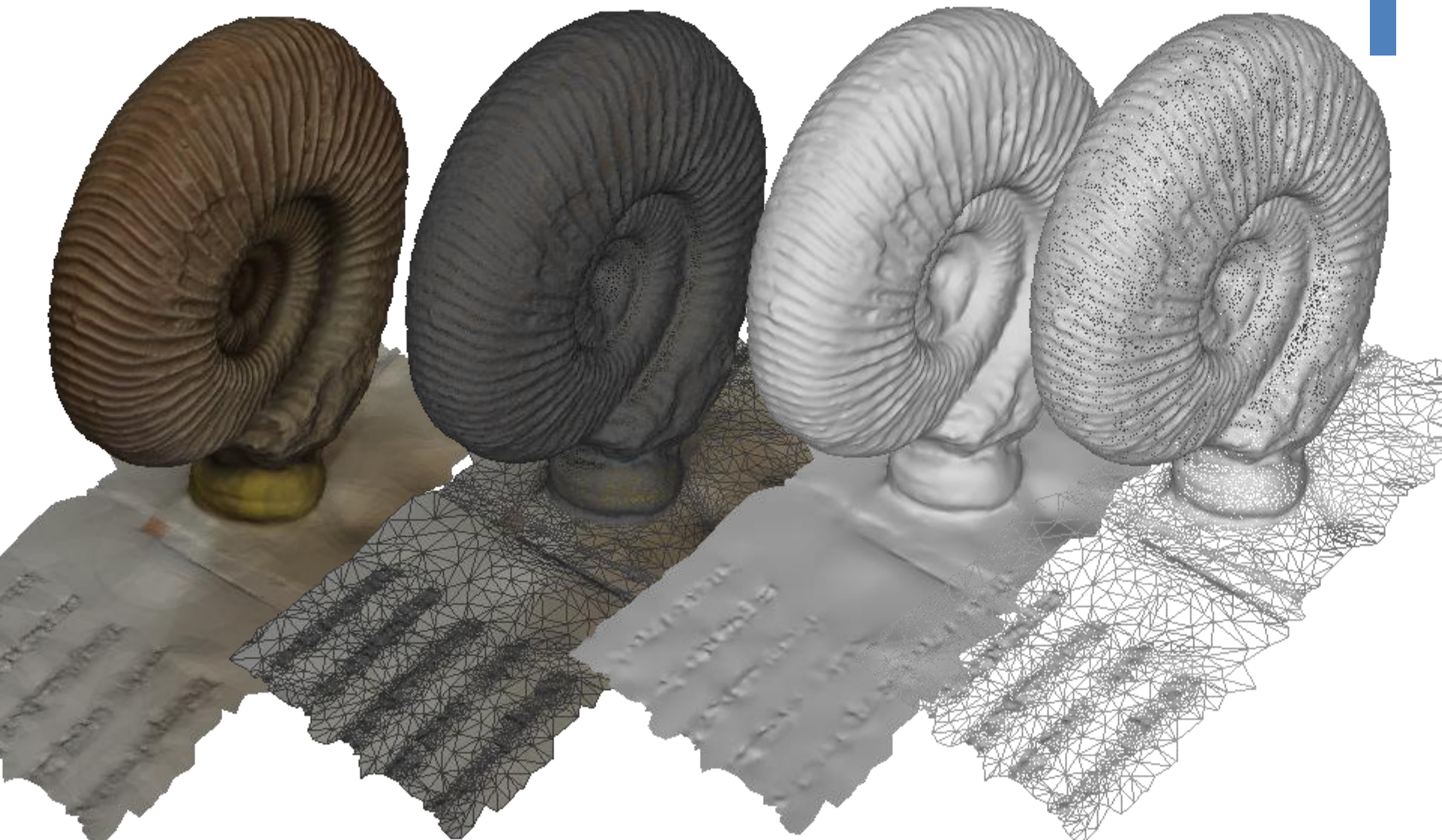





# EXCHANGE FORMATS

# + Stereolithography Interface

- Stereolithography AM process, released in 80's by 3-D Systems
- 3-D Systems developed interface between CAD systems and their machine
- STL files (\*.stl) allow CAD systems to interface with 3-D system machines
- Virtually all subsequent AM processes can use this same format (de-facto industry standard)
- Many CAD programs now can export the \*.stl file for easy conversion from CAD to part



# + STL Files (\*.stl)

- STL files were based on a program called Silverscreen CAD
- Silverscreen CAD represent boundary with all surfaces being approximated by polygons or groups of polygons
- \*.stl files use triangles or groups of triangles to approximate surfaces
- Accuracy depends on the triangle sizes (**Smaller facets produce a higher quality surface**)
- Triangles assigned normal vectors for outward surface normal
- Parts are defined by representing all their bounding surfaces as faceted surfaces, using the triangular patches



# + STL Files (\*.stl)

- STL files describe only the surface geometry of a three dimensional object without any representation of color, texture or other common CAD model attributes.
- An STL file describes a raw unstructured triangulated surface by the unit normal and vertices (ordered by the right-hand rule) of the triangles using a three-dimensional Cartesian coordinate system.



# + Example of \*.stl Representation

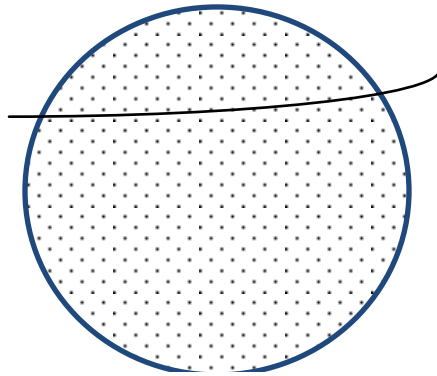

Representing  
a sphere

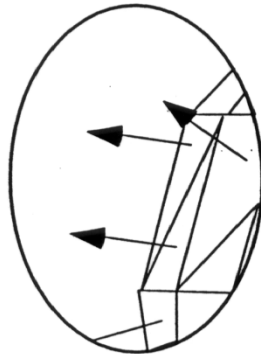
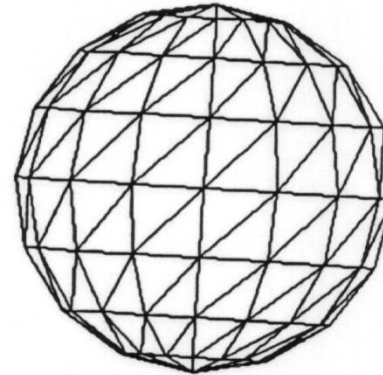

```
solid obj1
facet normal 1.457591e-01 -9.885599e-01 -3.877669e-02
  outer loop
    vertex 9.614203e+00 4.757629e+00 0.000000e+00
    vertex 7.875000e+00 4.501190e+00 0.000000e+00
    vertex 9.483117e+00 4.764183e+00 -6.598330e-01
  endloop
endfacet
facet normal 1.161178e-01 -9.870778e-01 -1.104267e-01
  outer loop
    vertex 9.483117e+00 4.764183e+00 -6.598330e-01
    vertex 7.875000e+00 4.501190e+00 0.000000e+00
    vertex 9.109818e+00 4.782848e+00 -1.219212e+00
  endloop
endfacet
facet normal 6.134766e-02 -9.843393e-01 -1.652652e-01
```

# + Example of \*.stl Representation

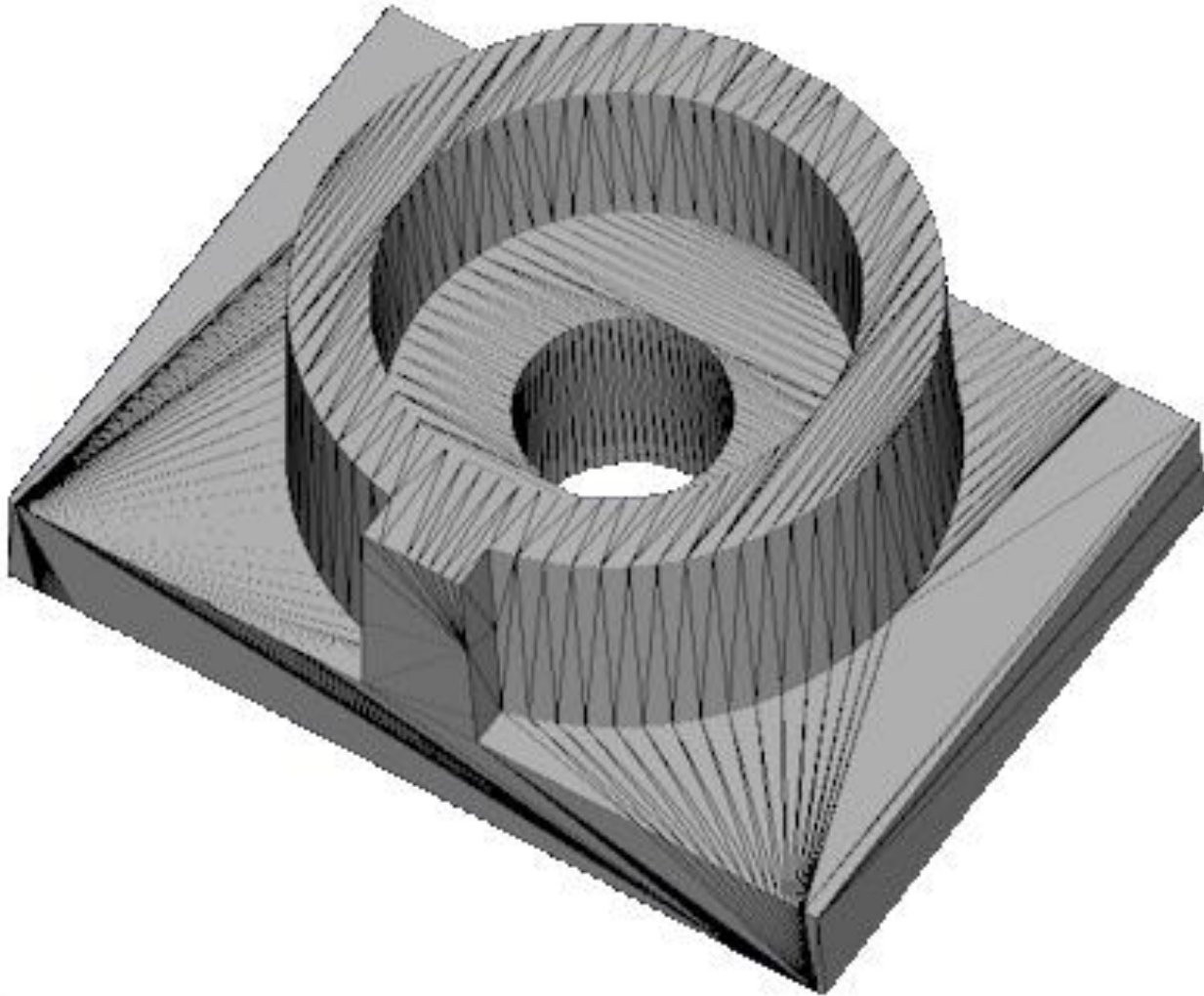

# + Existing Formats (1/2)



- 3D PDF
  - Proprietary, closed
- ISO 14649 (STEP-NC)
  - Mostly for NC control, G-Code
- STEP / IGES, SAT, Parasolid
  - Too complex, missing features e.g. no mesostructure
- X3D VRML
  - Mesh, color, texture, lighting

All: no provision for AM, e.g. materials, internal structure

# + Existing Formats (2/2)



- PLY
  - 3D Scanner data
- 3DS
  - Limited mesh size
- SLC
  - Limited information

All: no provision for AM, e.g. materials,  
internal structure



# + New format needed

- Tailor to AM community needs
  - No content constraints
- Retain Community Control
  - Not Proprietary
- Neutral
  - Avoids association with existing companies



# + Desired features

- simple
- ISO 9000-ish features like product tracking
- Interoperability within different manufacturers
- Compatible with FEA applications
- Identification of parent CAD program
- Restricted number of printings
- Support multiple shells
- Editable ASCII/Text format



# + Desired features

- Information about build orientation
- Stability/robustness
- No redundancy
- Volume validity
- Lock or encrypt the file with a password
- Ability to put a permanent 'watermark'
- Supporting geometry in native way
- Keep triangle mesh / No triangle mesh



# + Reaching consensus, adoption

- Non proprietary / open source
- Endorsement by major CAD / Manufacturers
- Use ASTM / Voting
- Backwards compatible (STL)
- Expandable, XML
- Publish for comments / discussion
- Open source software
- Conversion tools
- Limit the scope: Not a CAD model



# + Current STL



<b>Advantages</b>	<b>Disadvantages</b>
Simple	Geometry leaks
Sequential memory access*	No specified units
Portable	Unnecessary redundancy
	Incompatible with color, multiple materials, etc
	Poor scalability
*Does not require large amounts of RAM, critical in '80s	Lacks auxiliary information

# + The new proposed format

- AMF
  - Additive Manufacturing Format
  - Additive Manufacturing File



# + XML



- Meta-format: Format of formats
  - Text based
  - Easy to read/write/parse
  - Existing editing tools
  - Extensible
  - Highly compressible
- Mentioned by a number of constituents
  - E.g. Materialise
  - Based on work by J. Hiller (Cornell)

Addresses needs:  
Editable / Extensible /  
Readable / Open / Non  
proprietary

# + General Concept

- Part (objects) defined by regions and materials
  - Regions defined by triangular mesh
  - Materials defined by properties/names
- Mesh properties can be specified
  - Color
  - Tolerance
  - Texture
- Materials can be combined
  - Graded materials
  - Microstructure





# + Basic Structure

```
<?xml version="1.0"?>
<AMF>
  <Object PrintID = "0" units = "mm">
    <Mesh>
      <Vertices>
        <Vertex VertexID="0">
          <VertexLocation x="0" y="1.332" z="3.715"/>
        </Vertex>
        <Vertex VertexID="1">
          <VertexLocation x="0" y="1.269" z="3.715"/>
        </Vertex>
        ...
      </Vertices>

      <Region FillMaterialID = "0">
        <Triangle V1 = "0" V2 = "1" V3 = "3"/>
        <Triangle V1 = "0" V2 = "1" V3 = "4"/>
        ...
      </Region>
    </Mesh>
  </Object>
</AMF>
```

Addresses needs:  
Simple / Watertight /  
Backward Compatible  
(STL)



# + Compressibility

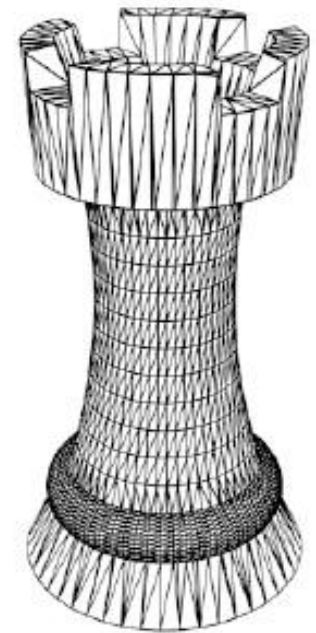
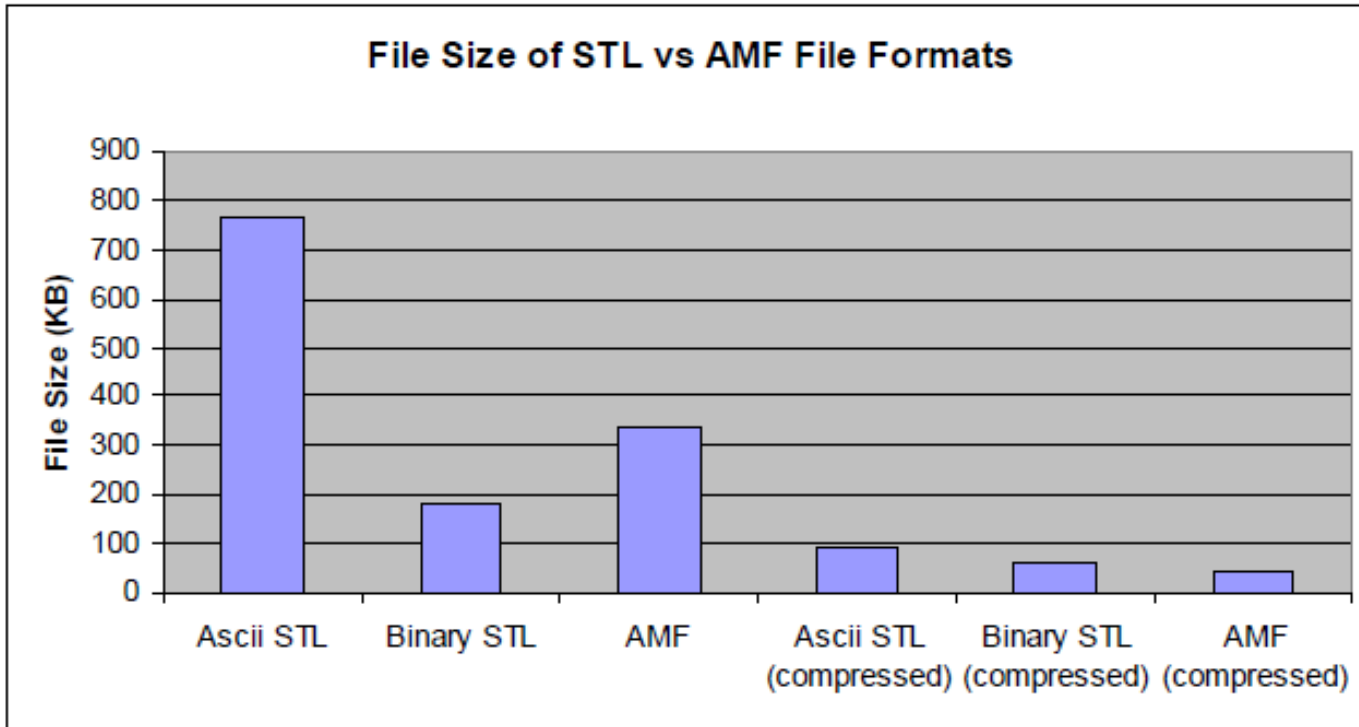

Addresses needs:  
Small /  
Compressible

# + Multiple Materials

```
<?xml version="1.0"?>
<AMF>
  <Palette>
    <Material MaterialID = "0">
      <Name>StiffMaterial</Name>
    </Material>
    <Material MaterialID = "1">
      <Name>FlexibleMaterial</Name>
    </Material>
  </Palette>

  <Object PrintID = "0" units = "mm">
    <Mesh>
      <Vertices>
        ...
      </Vertices>

      <Region FillMaterialID = "0">
        ...
      </Region>
      <Region FillMaterialID = "1">
        <Triangle V1 = "5" V2 = "6" V3 = "7"/>
        <Triangle V1 = "5" V2 = "7" V3 = "9"/>
        ...
      </Region>
    </Mesh>
  </Object>
</AMF>
```



Addresses needs:  
Multiple Materials, No  
leaks between regions  
(shared vertices)

# + Graded Materials

```
<?xml version="1.0"?>
<AMF>
  <Palette>
    <Material MaterialID = "0">
      <Name>StiffMaterial</Name>
    </Material>
    <Material MaterialID = "1">
      <Name>FlexibleMaterial</Name>
    </Material>
    <Material MaterialID = "2">
      <Name>GradientMaterial</Name>
      <Equation UseMaterialID = "0">0.30*X</Equation>
      <Equation UseMaterialID = "1">0.30*(1-X)</Equation>
    </Material>
  </Palette>

  <Object PrintID = "0" units = "mm">
    ...
  </Object>
</AMF>
```



# + Microstructure

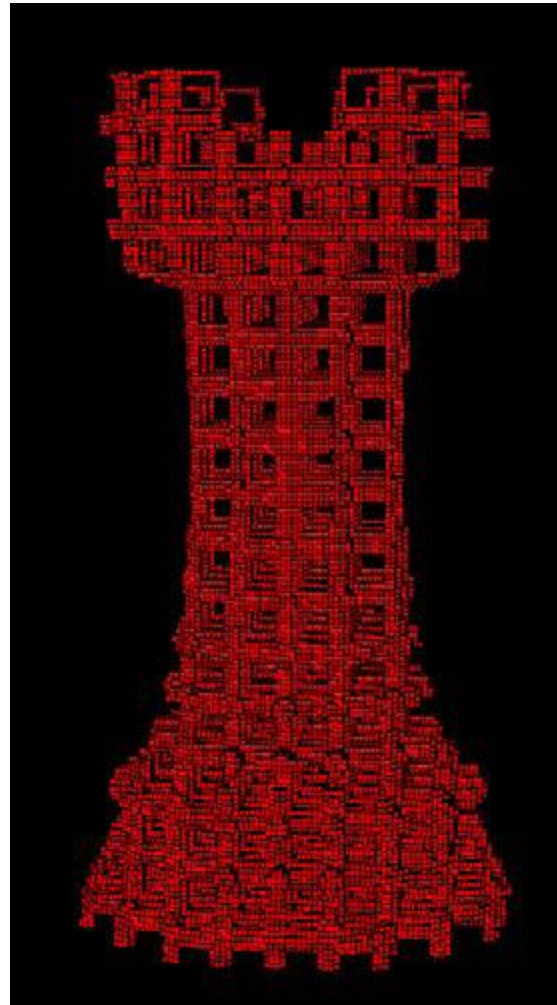

Addresses needs:  
Periodic  
meso/microstructure



# + Material properties

- By manufacturer's name
  - `<Name> ABS </Name>`
  - `<Name> Tango Black </Name>`
  - `<Name> Nylon 1234 </Name>`
- By physical property
  - `</Property Type="Elastic Modulus" Value="4E9">`
  - `</Property Type="Poisson Ratio" Value="1.2">`
- External reference (URL)

Addresses needs:  
Material  
specifications/libraries

# + Color and Graphics

- By volumetric region
  - Solid color
- By vertex
  - Specify Vertex color
  - Specify Vertex coordinate in a bitmap



# + Color and Graphics

```
<?xml version="1.0"?>
<AMF>
  <Object PrintID = "0" units = "mm">
    <Mesh>
      <ColorFile MapID="0">
        <File>Logo.bmp</File>
      </ColorFile>
      <Vertices>
        <Vertex VertexID="0">
          <VertexLocation x="0" y="1.332" z="3.715"/>
          <VertexMap UseMapID="0" MapXPixel="65" MapYPixel="87"/>
        </Vertex>
        <Vertex VertexID="1">
          <VertexLocation x="0" y="1.269" z="3.715"/>
          <VertexMap UseMapID="0" MapXPixel="64" MapYPixel="87"/>
        </Vertex>
        <Vertex VertexID="2">
          <VertexLocation x="0" y="1.310" z="3.587"/>
          <VertexMap UseMapID="0" MapXPixel="32" MapYPixel="10"/>
        </Vertex>
        ...
      </Vertices>
      <Region FillMaterialID = "0">
        <Color R = "0" G = "0" B = "0.5"/>
        <Triangle V1 = "0" V2 = "1" V3 = "2"/>
        <Triangle V1 = "0" V2 = "1" V3 = "4"/>
        ...
      </Region>
    </Mesh>
  </Object>
</AMF>
```





# + Tolerances

- By volumetric region
  - Nominal tolerance
  - Allowed variation from original volume
- By vertex
  - Specify point tolerance (?)
  - Point to point

# + Non-meshed geometry?

- Other representations are not mutually exclusive

- **Voxel maps**

- For digital/inkjet microstruc

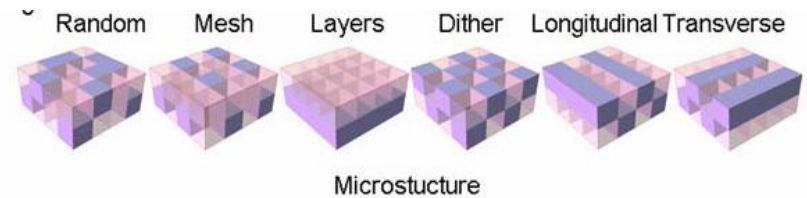

- **NURBS**

- Add slope vectors to some triangle mesh edges
  - Other STEP types?

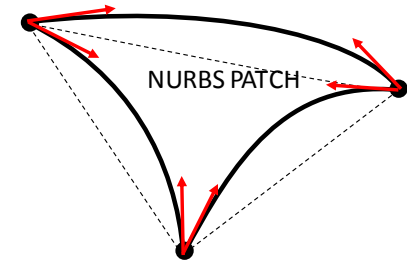
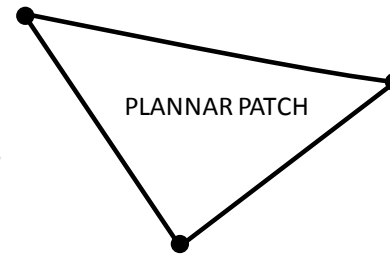

- **Functional Representations**

- implicit equations

```
<?xml version="1.0"?>
<AMF>
  <Object PrintID = "0" units = "mm">
    <FRep MaterialID = "0">
      <GeometryEquation>
        <![CDATA[X^2+Y^2+Z^2-4 <= 0 & Z >= 0]]>
      </GeometryEquation>
    </FRep>
  </Object>
</AMF>
```

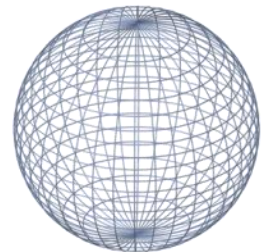

# + Nurbs patch

- Optionally add slope vectors to some triangle mesh edges to allow for very accurate geometry.
  - Perfect sphere can be made with ~20 patches

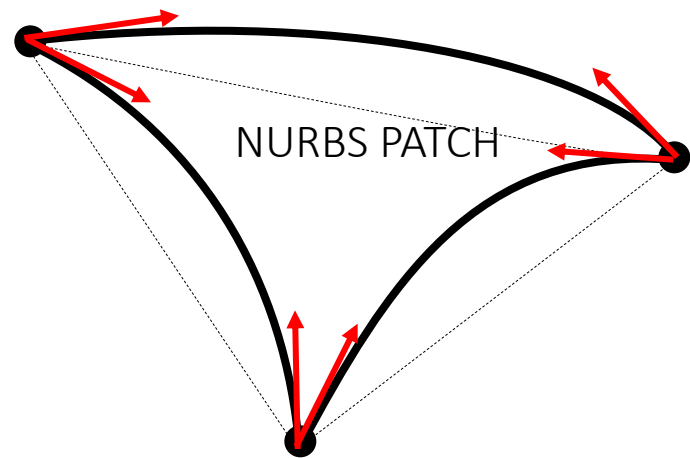
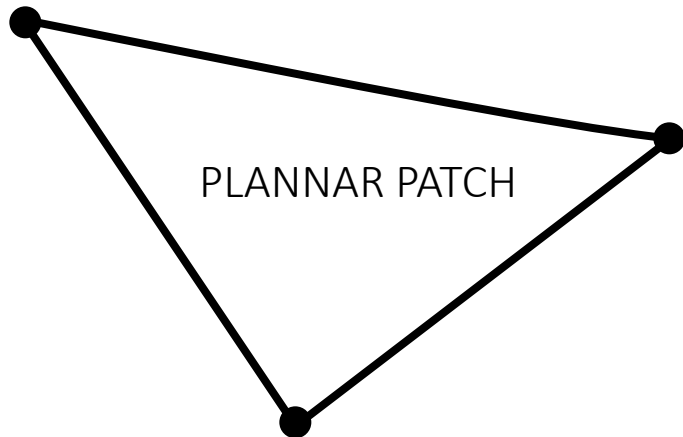

# + Print Constellation

- Print orientation
- Duplicated objects
- Sets of different objects
- Efficient nesting
- Hierarchical



# + Metadata

<Metadata>

<Datum ID="Author" Data="John Doe"></Datum>

<Datum ID="Company" Data="..."></Datum>

<Datum ID="Description" Data="..."></Datum>

<Datum ID="Originating CAD System" Data="..."></Datum>

<Datum ID="Originating CAD File" Data="..."></Datum>

<Datum ID="Comment" Data="..."></Datum>

</Metadata>

# + Encryption

<Metadata>

<Datum ID="Author" Data="John Doe"></Datum>

<Datum ID="Company" Data="..."></Datum>

<Datum ID="Description" Data="..."></Datum>

<Datum ID="Comment" Data="..."></Datum>

<Datum ID="Encryption" Data="Prompt"></Datum>

</Metadata>

```
<Mesh>
  <Vertices>
    <Vertex VertexID="0">
      <VertexLocation x="0" y="1.332" z="3.715"/>
    </Vertex>
    <Vertex VertexID="1">
      <VertexLocation x="0" y="1.269" z="3.715"/>
    </Vertex>
  </Vertices>
</Mesh>
```

# + Watermark / Copyright

<Metadata>

<Datum ID="Author" Data="John Doe"></Datum>

<Datum ID="Company" Data="..."></Datum>

<Datum ID="Description" Data="..."></Datum>

<Datum ID="Comment" Data="..."></Datum>

<Datum ID="Copyright" Data="Owner"></Datum>

</Metadata>

```
<Mesh>
  <Vertices>
    <Vertex VertexID="0">
      <VertexLocation x="0" y="1.332" z="3.715"/>
    </Vertex>
    <Vertex VertexID="1">
      <VertexLocation x="0" y="1.269" z="3.715"/>
    </Vertex>
  </Vertices>
</Mesh>
```

## + Other features

- URL can be used in lieu of material data to allow for external libraries
- Validation checksums
  - E.g. Original vs. actual part/region volumes
- Automatic error checking
  - Readers/writers must check for intact topology, e.g.
    - All nodes referenced by at least 3 triangles
    - All edges referenced exactly twice per region





# + ISO STANDARD

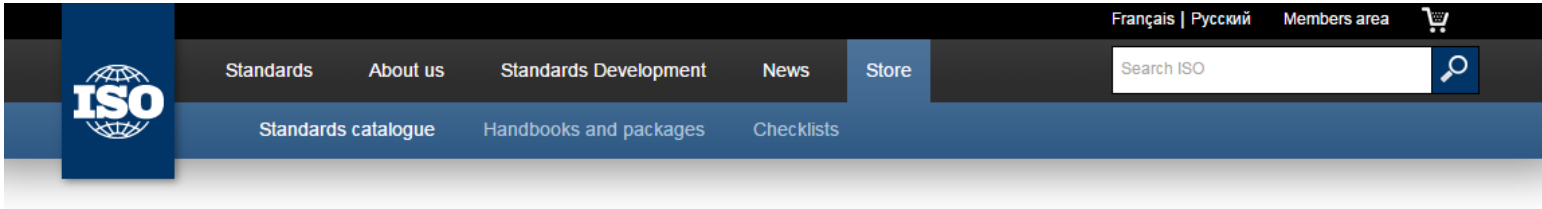

ISO Store > Store > Standards catalogue > By TC > ISO/TC 261 Additive manufacturing

## ISO/ASTM 52915:2013 <sup>®</sup>

Standard specification for additive manufacturing file format (AMF) Version 1.1

### Abstract

[Preview ISO/ASTM 52915:2013](#)

ISO/ASTM 52915:2013 describes a framework for an interchange format to address the current and future needs of additive manufacturing technology. For the last three decades, the STL file format has been the industry standard for transferring information between design programs and additive manufacturing equipment. An STL file contains information only about a surface mesh and has no provisions for representing color, texture, material, substructure, and other properties of the fabricated target object. As additive manufacturing technology is quickly evolving from producing primarily single-material, homogenous shapes to producing multimaterial geometries in full colour with functionally graded materials and microstructures, there is a growing need for a standard interchange file format that can support these features.

General information

Revisions

Corrigenda / Amendments

**Document published on:** 2013-06-01

**Edition:** 1 (Monolingual)

**ICS:** 35.240.50; 25.040.20

**Status:** ✓ Published

**Stage:** 90.92 (2014-09-17)

**TC/SC:** ISO/TC 261

**Number of Pages:** 15

FORMAT ? LANGUAGE

✓ PDF English

PAPER English

CHF 88 [Add to basket](#)

#### Keep up to date with ISO

Sign up to our newsletter for the latest news, views and product information

[Subscribe](#)

#### Got a question?

[Check out our FAQs](#)

[Email customer services](#)

# + 3MF format

<http://3mf.io/>

## 3MF design considerations

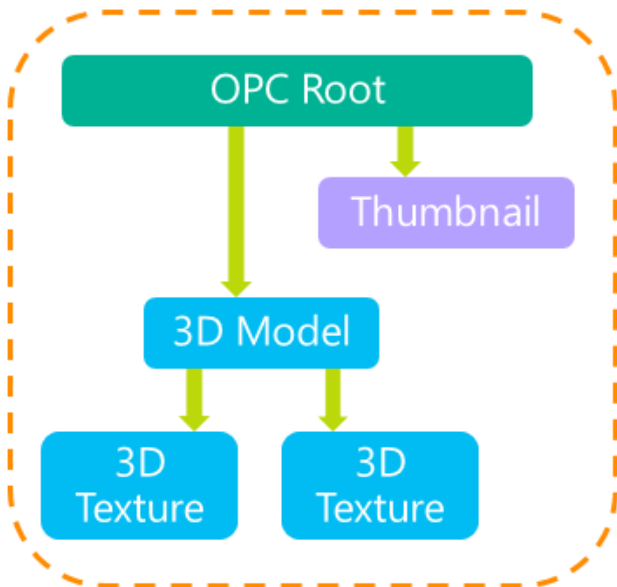

### Complete

- Open Packaging Conventions (OPC)

### Compact

- ZIP package
- References avoid duplication

### Human-readable

- XML
- Well-known binary formats (e.g. PNG, JPEG)



# + MeshLab

<http://meshlab.sourceforge.net>

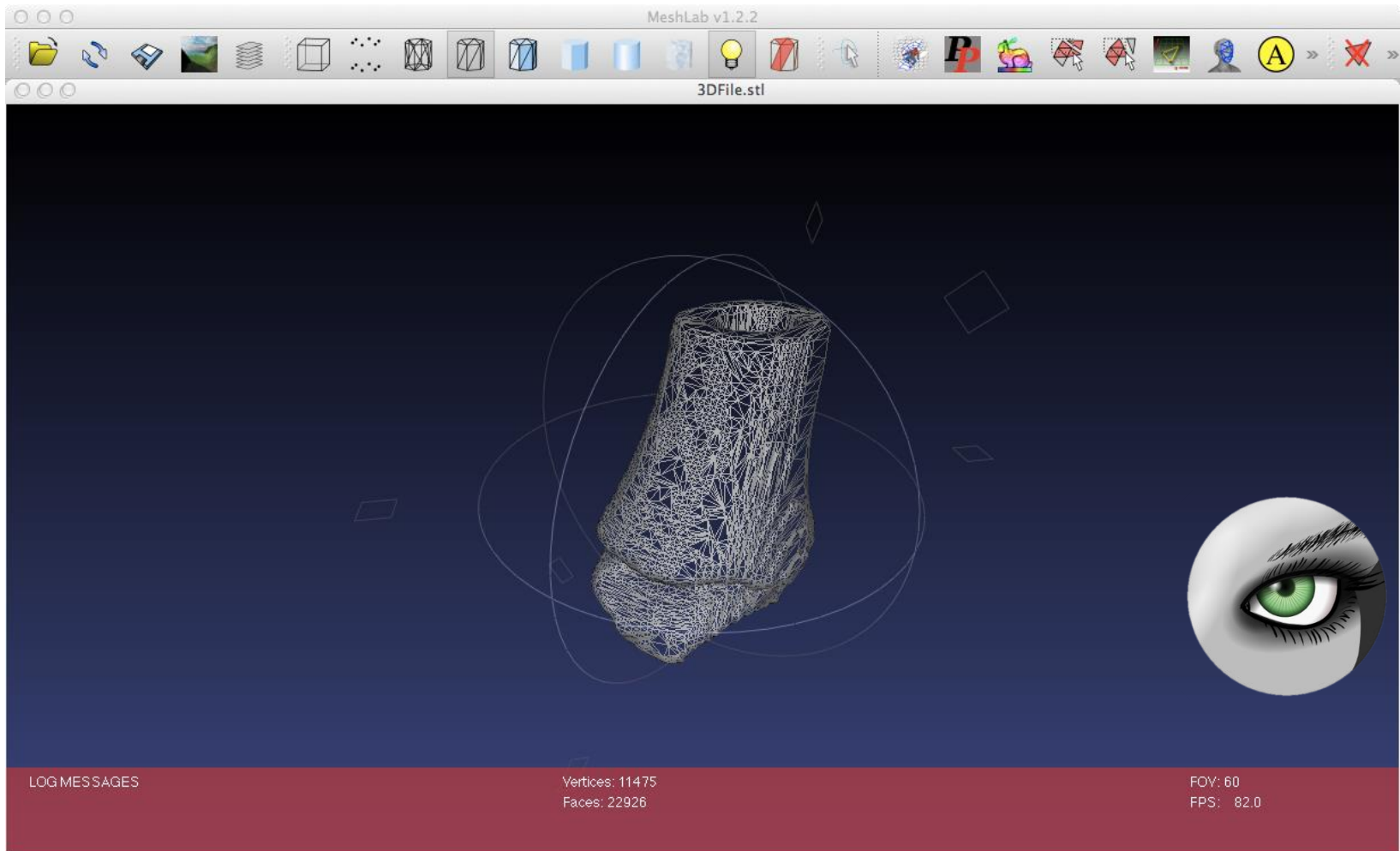

# + Netfabb

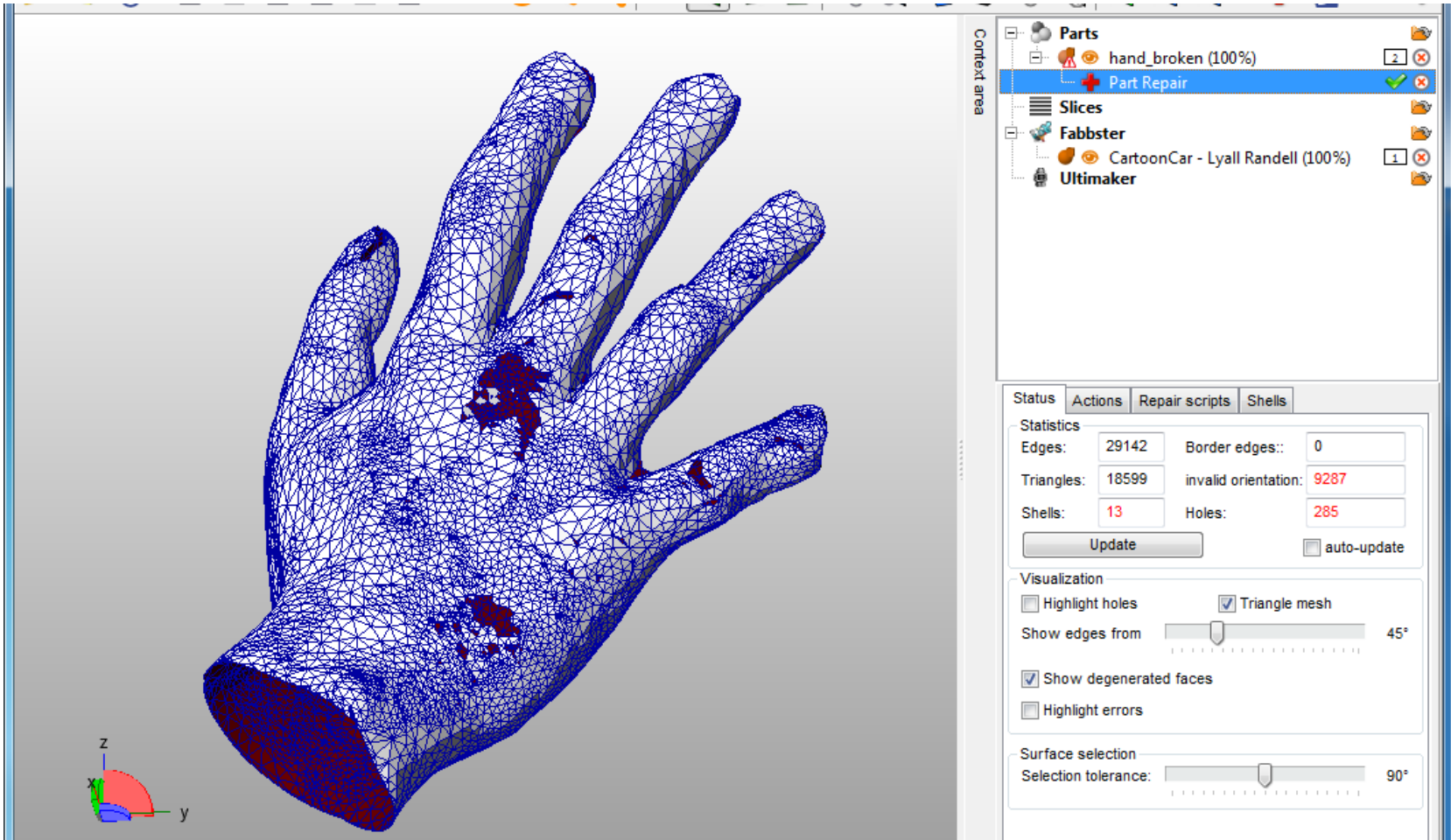

# + Meshmixer

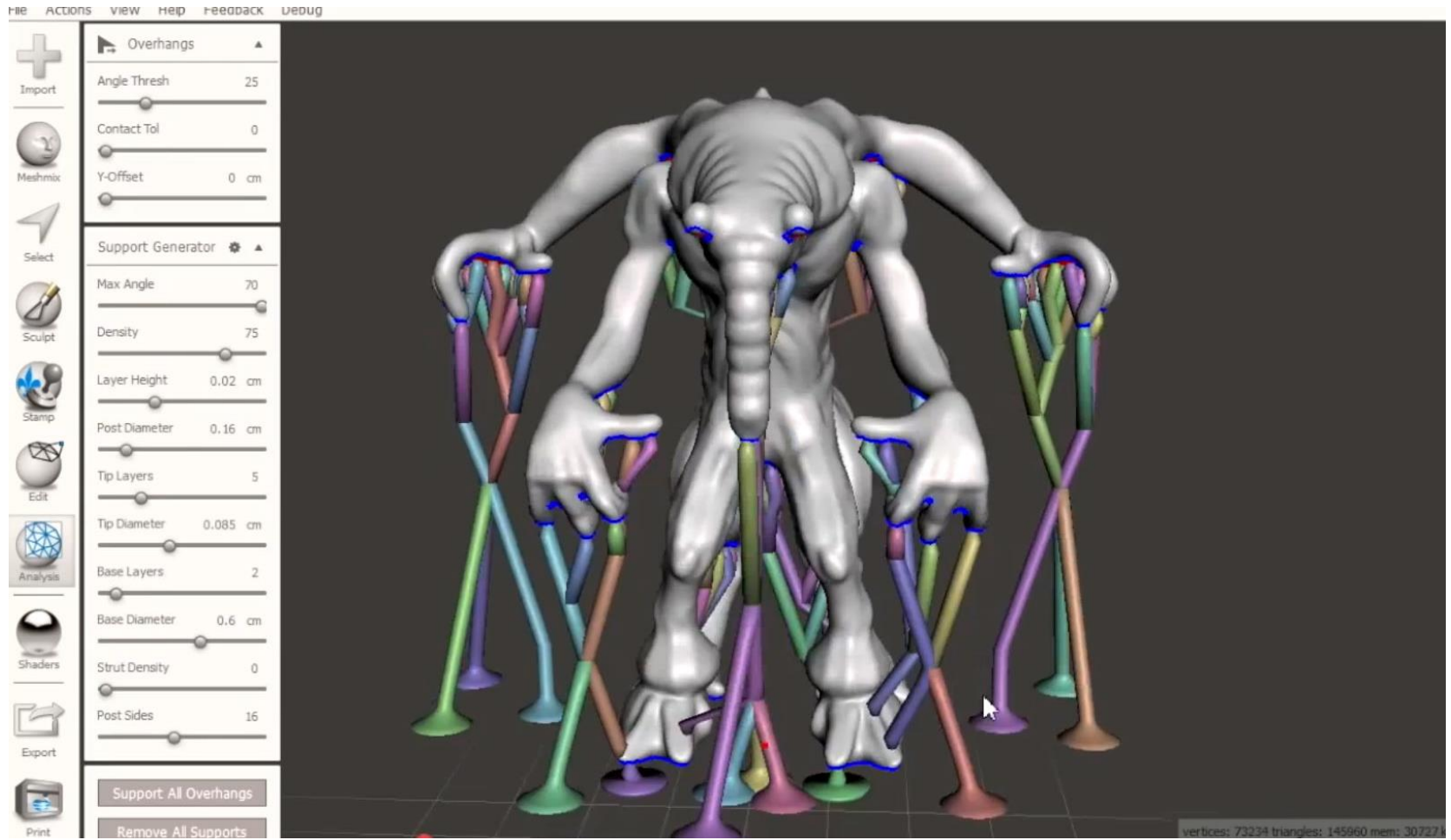

# FROM CAD TO CAM

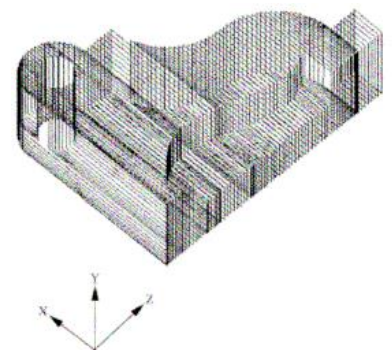
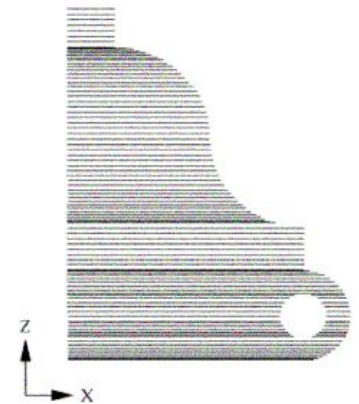

# + From CAD to CAM

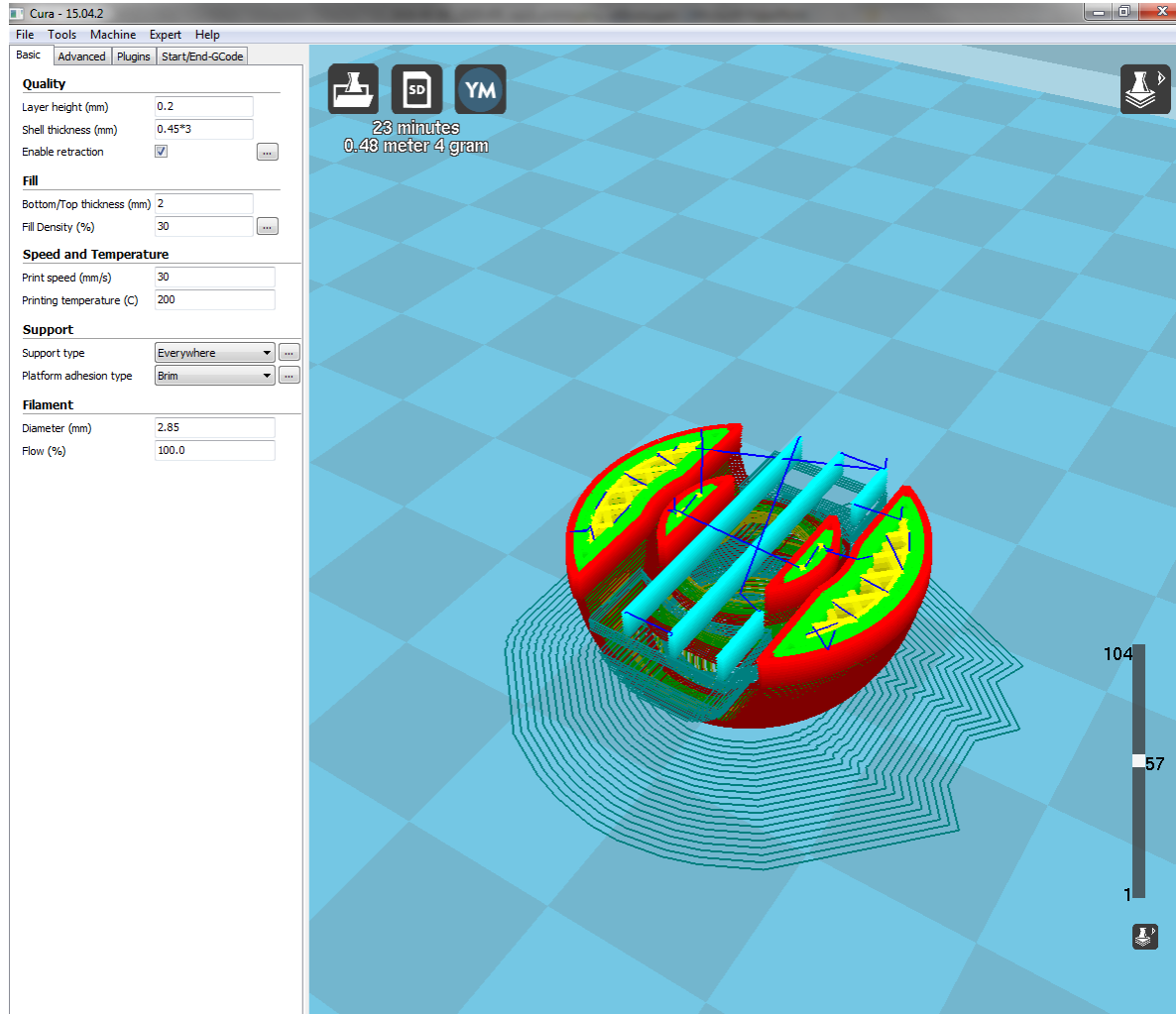

# + Processing of \*.stl Files

- After the CAD system has generated \*.stl file, it can be passed to the AM machine
- Machine then processes the \*.stl file, slicing it into many thin layers stacked on one another. The resulting files are called slice files.
- The shapes of the slices represent cross sections
- In AM processes thick solid sections of material are often removed and replaced with cross hatching
- Thus AM parts are usually hollow, with cross hatching on the inside to add strength/stability





# + Support material

- Some solid freeform fabrication techniques use two materials in the course of constructing parts.
- The first material is the part material and the second is the support material (to support overhanging features during construction).
- The support material is later removed by heat or dissolved away with a solvent or water.



# + Support material

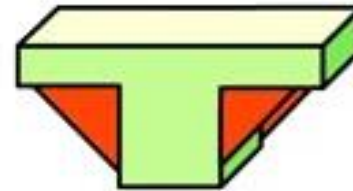
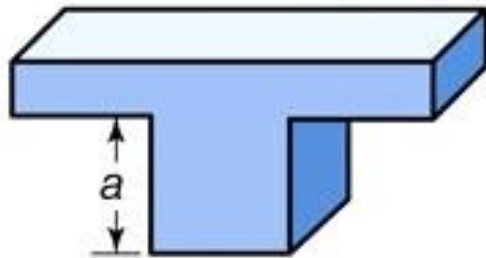

Island

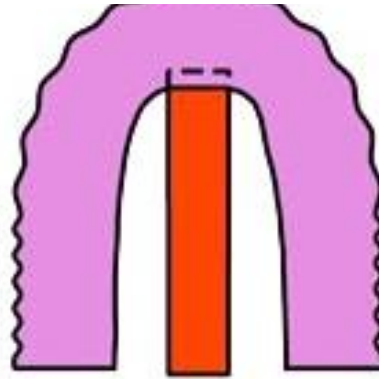

Ceiling within an arch

Gussets

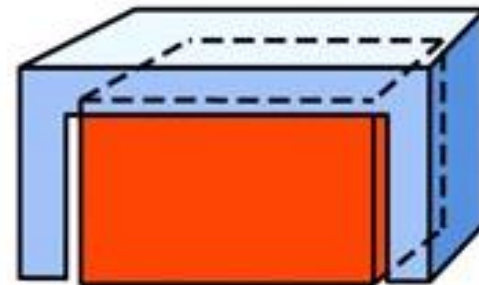

Ceiling



# + Patterning



**Vector**

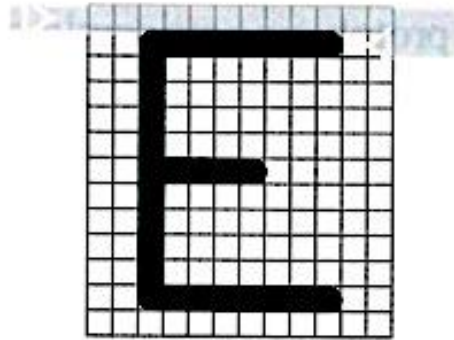

**Raster**

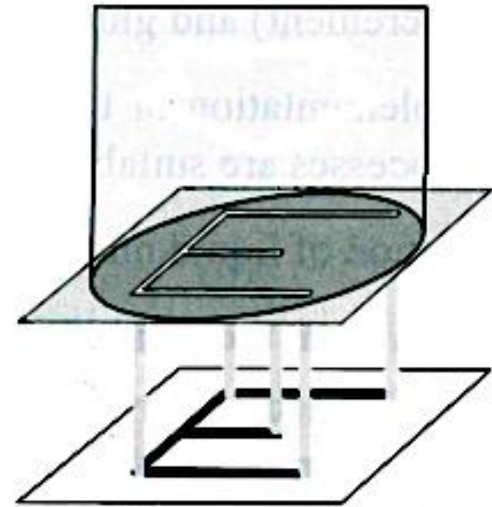

**Projection**

# + Basic Machine Axes: 3 axis

- Cartesian Robot: 3 axis
  - X – axis (table left and right)
  - Y – axis (table in and out)
  - Z – axis (usually the extruder)

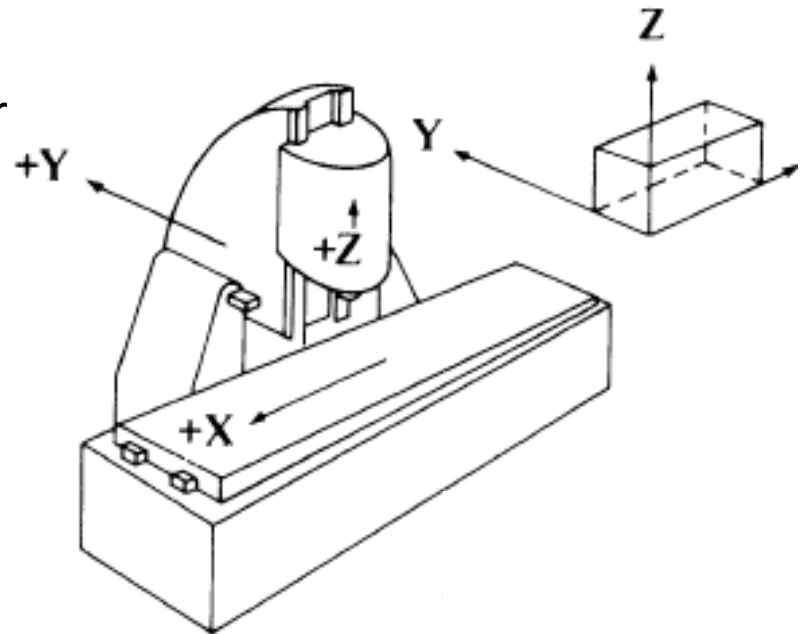

# + G-CODE

- G – Code Programming
- Originally called the “Word Address” programming format.
- Processed one line at a time sequentially.



# + Word address format

- Word address was developed as a tape programming format.
  - Another name for “word address” is “variable block” format, so named because the program lines (blocks) may vary in length according to the information contained in them.
  - Earlier tape formats required an entry for all possible machine registers. In these earlier formats, a zero was programmed as a null input if the register values were to be unaffected, but in word address, the blocks need only contain necessary information. Although developed as a tape format, word address is used as the format for manual data input on many CNC machines.
- Addresses
  - The block format for word address is as follows:
  - N ... G ... X ... Y ... Z ... I ... J ... K ... F ... H ... H ... S ... T ... M ...
  - Only the information needed on a line need be given. Each of the letters is called an address (or word)

# + Common Format of a Block

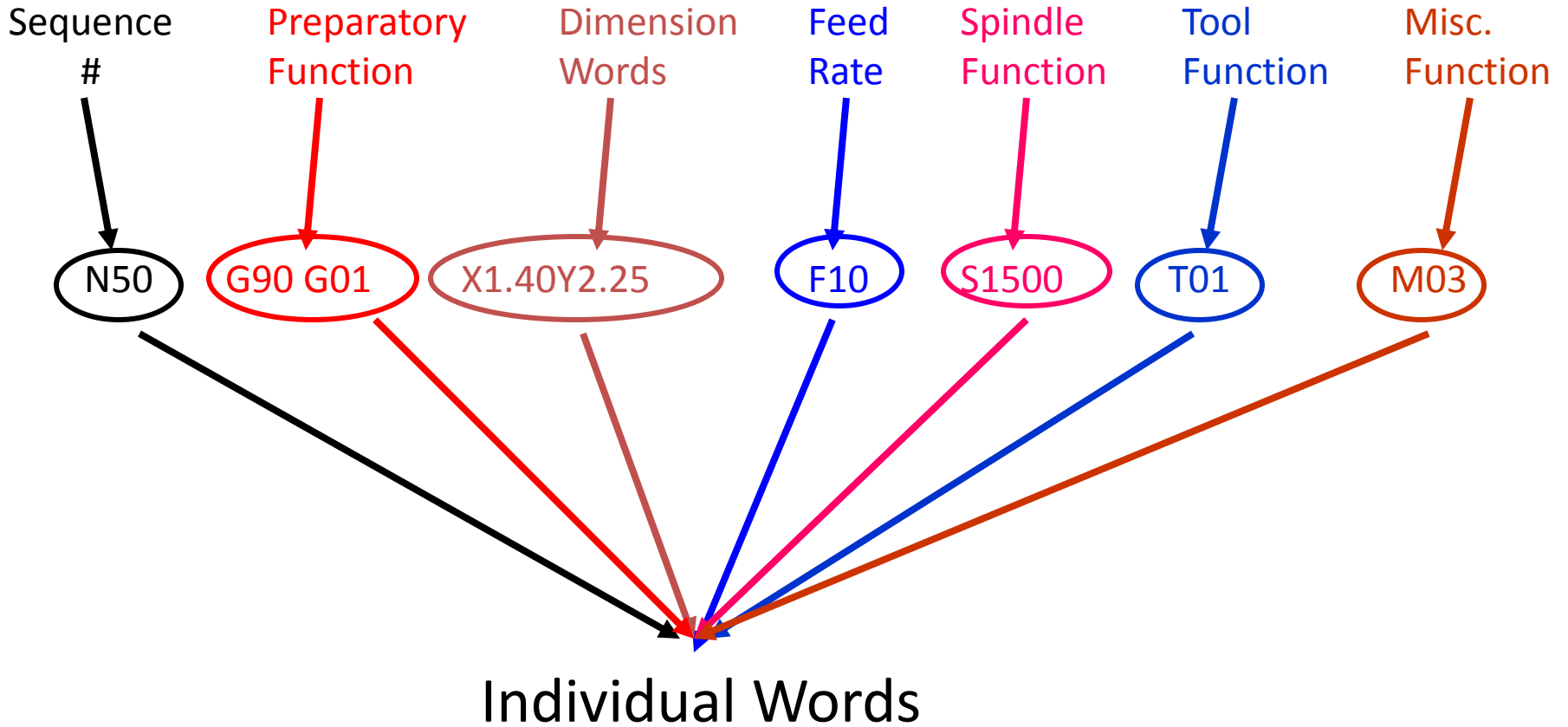

# + Word address

- Reserved Code Words Worksheet
  - N – Sequence or line number
  - G – Preparatory function
  - ...
- Dimension Words:
  - X
  - Y
  - Z





# + Word Address 1/3



- N – Sequence or line number
  - A tag that identifies the beginning of a block of code. N numbers are ignored by the controller during the program execution. It is used by operators to locate specific lines of a program when entering data or verifying the program operation.
- G – Preparatory function
  - G words specify the mode in which the milling machine is to move along its programmed axes. Preparatory functions are called prep functions or, more commonly **G codes**

# + Word Address 2/3



- Dimension Words
  - X – Distance or position in X direction
  - Y – Distance or position in Y direction
  - Z – Distance or position in Z direction
- M – Miscellaneous functions
  - M words specify CNC machine functions not related to dimensions or axial movements.

## + Word Address 3/3

- F – Feed rate (inches per minute or millimeters per minute)
  - Rate at which cutting tool moves along an axis.
- S – Spindle speed (rpm – revolutions per minute)
  - Controls spindle rotation speed.
- T – Tool number
  - Specifies tool to be selected.



## + G Word

- G words or codes tell the machine to perform certain functions. Most G words are modal which means they remain in effect until replaced by another modal G code.



# + Common G Codes

- G00 – Rapid positioning mode
  - Tool is moved along the shortest route to programmed X,Y,Z position. Usually NOT used for cutting.
- G01 – Linear Interpolation mode
  - Tool is moved along a straight-line path at programmed rate of speed.
- G02 – Circular motion clockwise (cw)
- G03 – Circular motion counter clockwise (ccw)



## + M Word

- M words tell the machine to perform certain machine related functions, such as: turn spindle on/off, coolant on/off, or stop/end program.



# + Esempio G-Code

```
;Generated with Cura_SteamEngine 13.11.2
M109 T0 S227.000000
T0
;Sliced ?filename? at: Tue 26-11-2013 17:33:05
;Basic settings: Layer height: 0.2 Walls: 0.8 Fill: 20
;Print time: #P_TIME#
;Filament used: #F_AMNT#m #F_WGHT#g
;Filament cost: #F_COST#
G21 ;metric values
G90 ;absolute positioning
M107 ;start with the fan off
G28 X0 Y0 ;move X/Y to min endstops
G28 Z0 ;move Z to min endstops
G1 Z15.0 F?max_z_speed? ;move the platform
down 15mm
G92 E0 ;zero the extruded length
G1 F200 E3 ;extrude 3mm of feed stock
```

```
G92 E0 ;zero the extruded length again
G1 F9000
M117 Printing...

;Layer count: 179
;LAYER:0
M107
G0 F3600 X87.90 Y78.23 Z0.30
;TYPE:SKIRT
G1 F2400 E0.00000
G1 F1200 X88.75 Y77.39 E0.02183
G1 X89.28 Y77.04 E0.03342
G1 X90.12 Y76.69 E0.05004
G1 X90.43 Y76.63 E0.05591
G1 X91.06 Y76.37 E0.06834
...
```

# + Slic3r

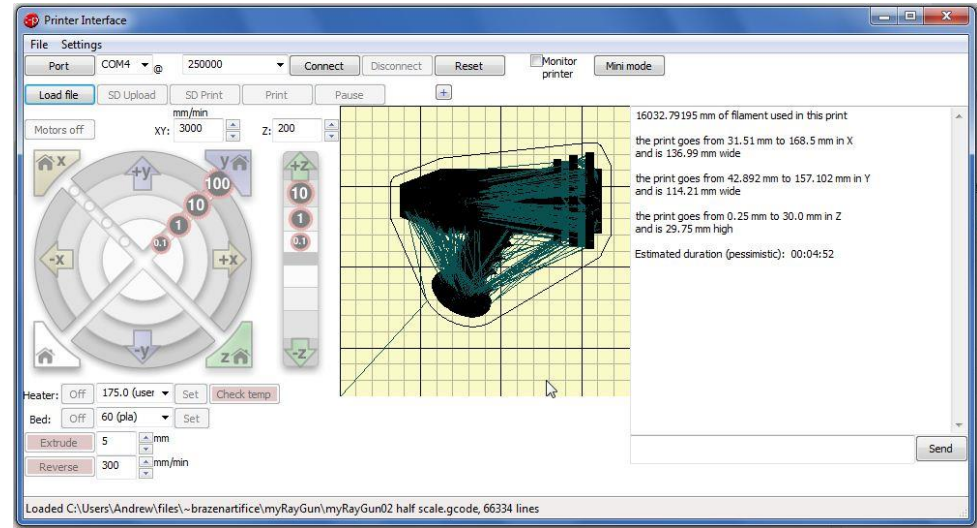

<http://slic3r.org>



# + Cura

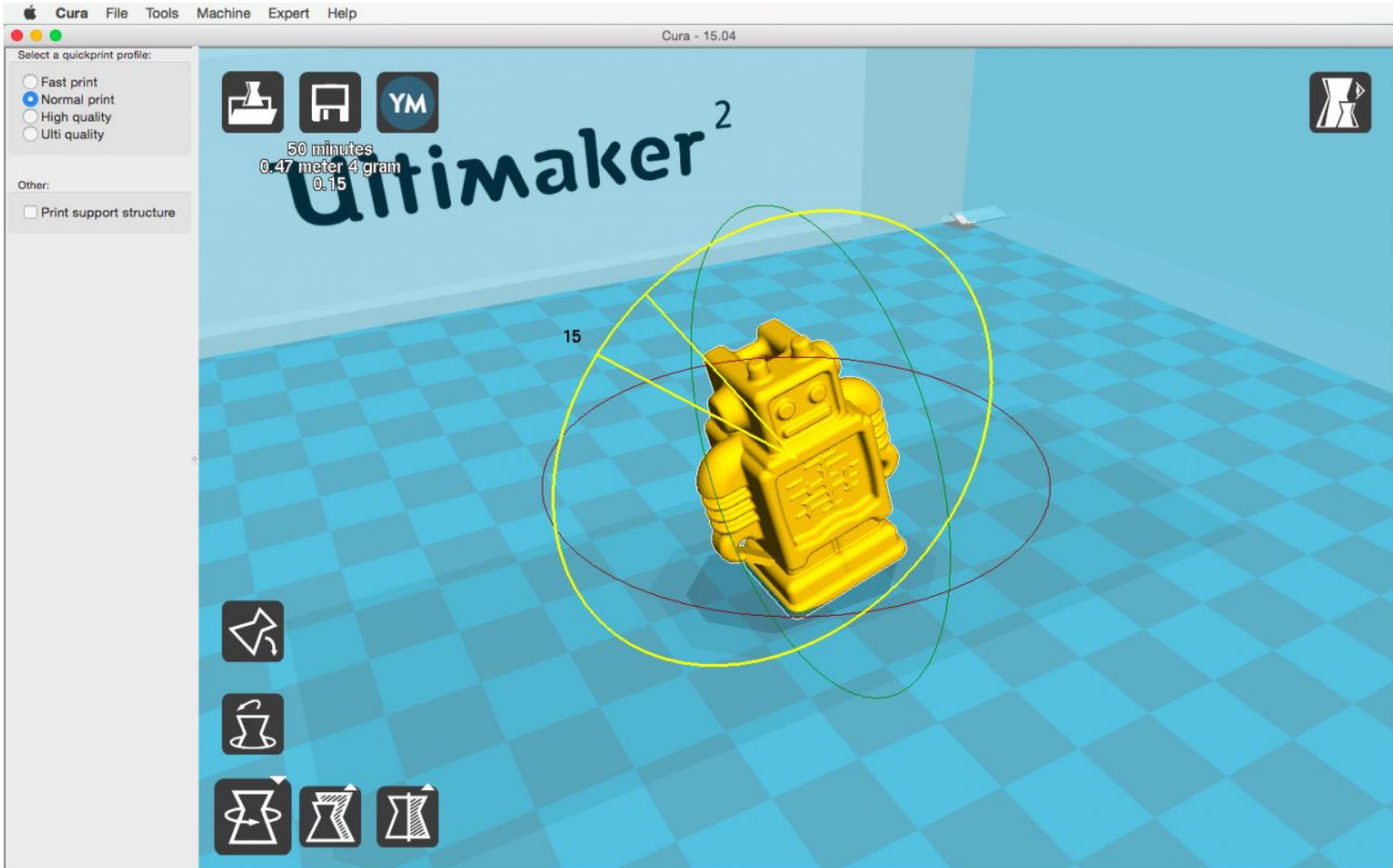

<https://ultimaker.com/en/products/cura-software>

# + Repetier Host

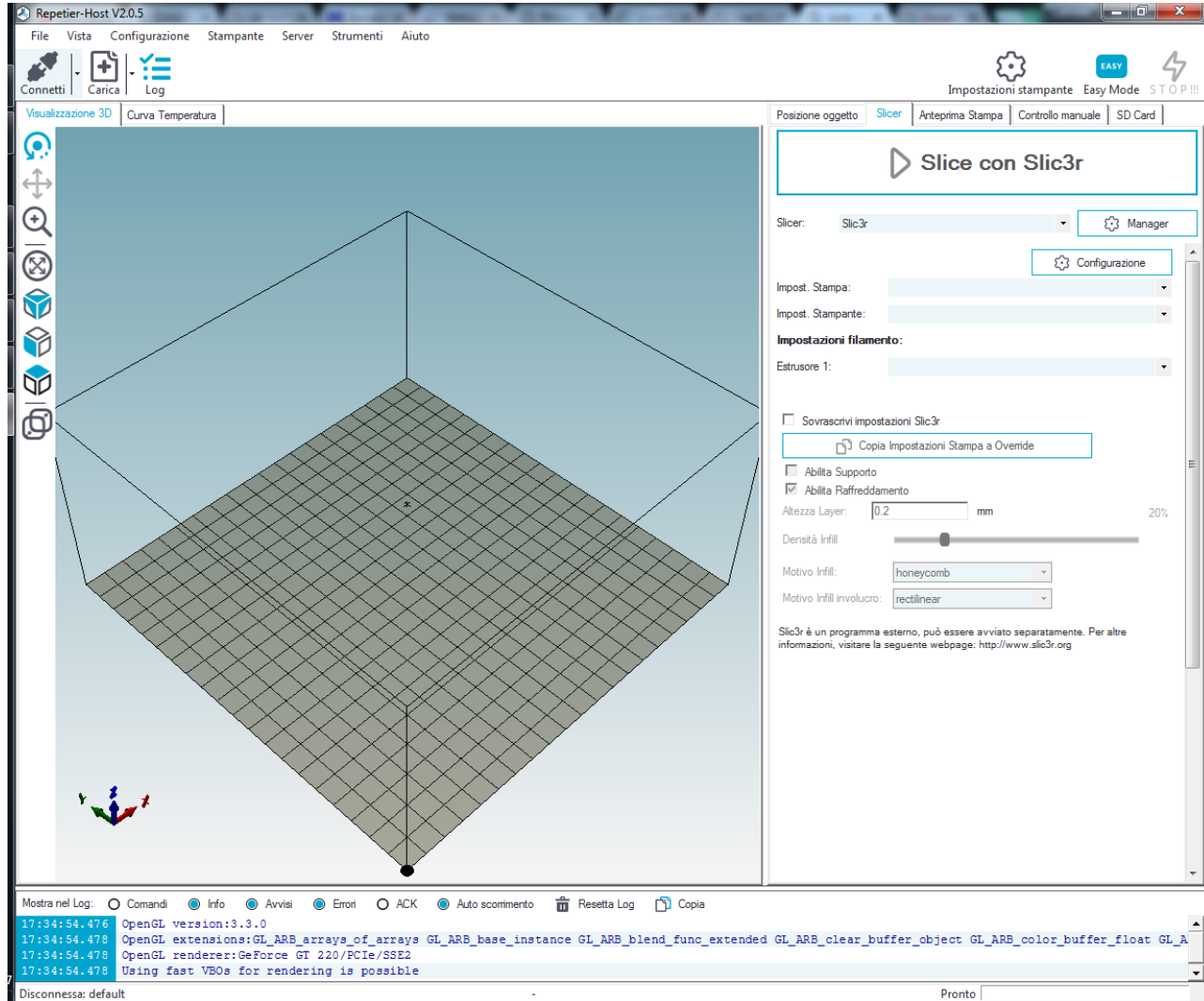

<https://www.repetier.com/download-now/>